

BUNN®

LCA-2 LP

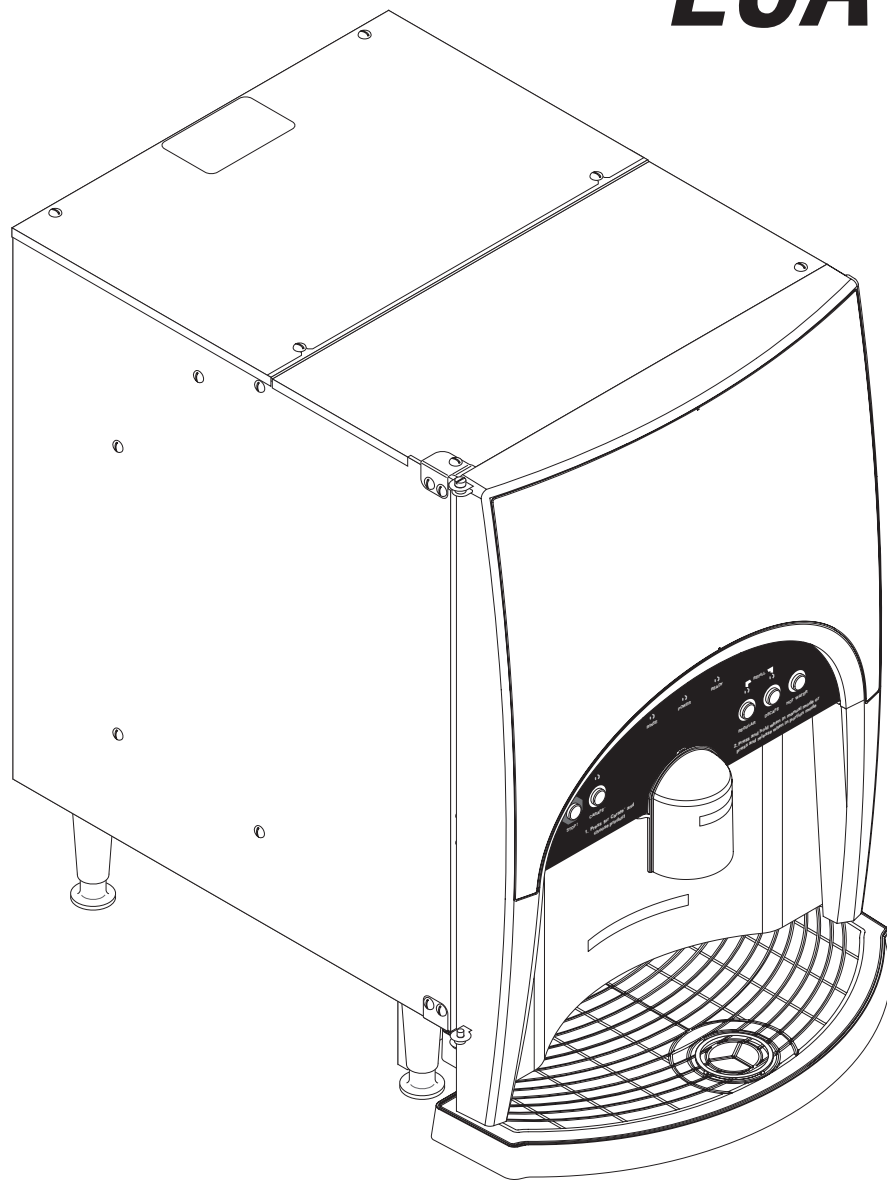

ILLUSTRATED PARTS CATALOG

Designs, materials, weights, specifications, and dimensions for equipment or replacement parts are subject to change without notice.

BUNN-O-MATIC CORPORATION

POST OFFICE BOX 3227

SPRINGFIELD, ILLINOIS 62708-3227

PHONE: (217) 529-6601 FAX: (217) 529-6644



BUNN-O-MATIC COMMERCIAL PRODUCT WARRANTY

Bunn-O-Matic Corp. ("BUNN") warrants equipment manufactured by it as follows:

- 1) Airpots, thermal carafes, decanters, GPR servers, iced tea/coffee dispensers, MCR/MCP/MCA single cup brewers, thermal servers and ThermoFresh® servers (mechanical and digital) 1 year parts and 1 year labor.
- 2) All other equipment - 2 years parts and 1 year labor plus added warranties as specified below:
 - a) Electronic circuit and/or control boards - parts and labor for 3 years.
 - b) Compressors on refrigeration equipment - 5 years parts and 1 year labor.
 - c) Grinding burrs on coffee grinding equipment to grind coffee to meet original factory screen sieve analysis - parts and labor for 4 years or 40,000 pounds of coffee, whichever comes first.

These warranty periods run from the date of installation BUNN warrants that the equipment manufactured by it will be commercially free of defects in material and workmanship existing at the time of manufacture and appearing within the applicable warranty period. This warranty does not apply to any equipment, component or part that was not manufactured by BUNN or that, in BUNN's judgment, has been affected by misuse, neglect, alteration, improper installation or operation, improper maintenance or repair, non periodic cleaning and descaling, equipment failures related to poor water quality, damage or casualty. In addition, the warranty does not apply to replacement of items subject to normal use including but not limited to user replaceable parts such as seals and gaskets. This warranty is conditioned on the Buyer 1) giving BUNN prompt notice of any claim to be made under this warranty by telephone at (217) 529-6601 or by writing to Post Office Box 3227, Springfield, Illinois 62708-3227; 2) if requested by BUNN, shipping the defective equipment prepaid to an authorized BUNN service location; and 3) receiving prior authorization from BUNN that the defective equipment is under warranty.

THE FOREGOING WARRANTY IS EXCLUSIVE AND IS IN LIEU OF ANY OTHER WARRANTY, WRITTEN OR ORAL, EXPRESS OR IMPLIED, INCLUDING, BUT NOT LIMITED TO, ANY IMPLIED WARRANTY OF EITHER MERCHANTABILITY OR FITNESS FOR A PARTICULAR PURPOSE. The agents, dealers or employees of BUNN are not authorized to make modifications to this warranty or to make additional warranties that are binding on BUNN. Accordingly, statements by such individuals, whether oral or written, do not constitute warranties and should not be relied upon.

If BUNN determines in its sole discretion that the equipment does not conform to the warranty, BUNN, at its exclusive option while the equipment is under warranty, shall either 1) provide at no charge replacement parts and/or labor (during the applicable parts and labor warranty periods specified above) to repair the defective components, provided that this repair is done by a BUNN Authorized Service Representative; or 2) shall replace the equipment or refund the purchase price for the equipment.

THE BUYER'S REMEDY AGAINST BUNN FOR THE BREACH OF ANY OBLIGATION ARISING OUT OF THE SALE OF THIS EQUIPMENT, WHETHER DERIVED FROM WARRANTY OR OTHERWISE, SHALL BE LIMITED, AT BUNN'S SOLE OPTION AS SPECIFIED HEREIN, TO REPAIR, REPLACEMENT OR REFUND.

In no event shall BUNN be liable for any other damage or loss, including, but not limited to, lost profits, lost sales, loss of use of equipment, claims of Buyer's customers, cost of capital, cost of down time, cost of substitute equipment, facilities or services, or any other special, incidental or consequential damages.

392, A Partner You Can Count On, Air Infusion, AutoPOD, AXIOM, BrewLOGIC, BrewMETER, Brew Better Not Bitter, BrewWISE, BrewWIZARD, BUNN Espresso, BUNN Family Gourmet, BUNN Gourmet, BUNN Pour-O-Matic, BUNN, BUNN with the stylized red line, BUNNlink, Bunn-O-Matic, Bunn-O-Matic, BUNNserve, BUNNSERVE with the stylized wrench design, Cool Froth, DBC, Dr. Brew stylized Dr. design, Dual, Easy Pour, EasyClear, EasyGard, FlavorGard, Gourmet Ice, Gourmet Juice, High Intensity, iMIX, Infusion Series, Intellisteam, My Café, Phase Brew, PowerLogic, Quality Beverage Equipment Worldwide, Respect Earth, Respect Earth with the stylized leaf and coffee cherry design, Safety-Fresh, savemycoffee.com, Scale-Pro, Silver Series, Single, Smart Funnel, Smart Hopper, SmartWAVE, Soft Heat, SplashGard, The Mark of Quality in Beverage Equipment Worldwide, ThermoFresh, Titan, trifacta, TRIFECTA (stylized logo), Velocity Brew, Air Brew, Beverage Bar Creator, Beverage Profit Calculator, Brew better, not bitter., Build-A-Drink, BUNNSource, Coffee At Its Best, Cyclonic Heating System, Daypart, Digital Brewer Control, Element, Milk Texturing Fusion, Nothing Brews Like a BUNN, Picture Prompted Cleaning, Pouring Profits, Signature Series, Sure Tamp, Tea At Its Best, The Horizontal Red Line, Ultra are either trademarks or registered trademarks of Bunn-O-Matic Corporation. The commercial trifacta® brewer housing configuration is a trademark of Bunn-O-Matic Corporation.

TABLE OF CONTENTS

Cabinet Assembly	8
Dispense Valve and Mixing Chamber	18
Door Assembly	6
Electrical Components	20
Housing, Panels & Drip Tray	4
Numerical Index.....	22
Pump Assembly.....	10
Tank Assembly	16
Water Inlet & Tank Drain (Early Models)	12
Water Inlet & Tank Drain (Early Models)	14

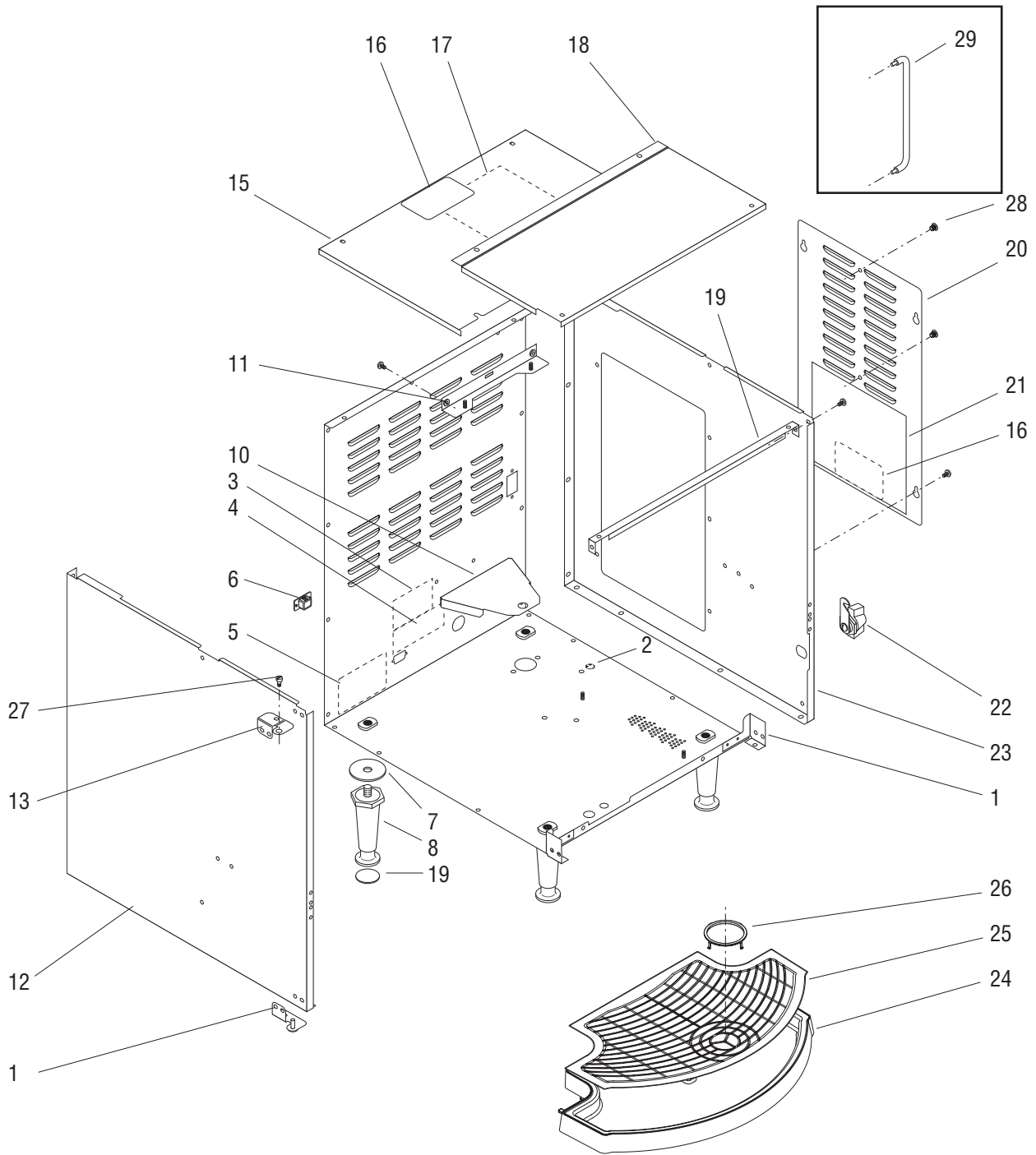

HOUSING, PANELS AND DRIP TRAY

ITEM	PART NO.	QTY.	DESCRIPTION
1	38774.1000	1	Housing w/Decals (Models w/Horton Inlet Valve)(Includes items 2-5)
	41321.1000	1	Housing w/Decals (Models w/Eltek Inlet Valve)(Includes items 2-5)
2	00824.0002	1	Decal, Ground Screw
3	00986.0002	1	Decal, Warning - Electrical
4	00656.0001	1	Decal, Comply to Plumbing Code
5	-----	1	Machine Data Plate (Not serviced)
6	36398.0000	1	Plug, BunnLink Access (Not used in all applications)
7	01526.0001	4	Washer
8	26528.0000	4	Leg
9	03996.0000	4	Pad, Non-skid
10	36941.0000	1	Bracket, Lower Tank Mount
	01315.0005	2	Screw, Truss Head BLK #8-32 x .38"
11	34118.0001	1	Bracket, Upper Tank Mount
	01315.0005	2	Screw, Truss Head BLK #8-32 x .38"
12	37708.0003	1	Panel, Left Side
	01315.0005	7	Screw, Truss Head BLK #8-32 x .38"
13	37578.0001	1	Hinge Bracket, Upper
	01315.0005	3	Screw, Truss Head BLK #8-32 x .38"
14	37716.0001	1	Hinge Bracket, Lower
	01315.0005	3	Screw, Truss Head BLK #8-32 x .38"
15	36945.1000	1	Top Cover w/Decals, Rear (Includes items 16 & 17)
	01315.0005	2	Screw, Truss Head BLK #8-32 x .38"
16	37881.0000	2	Decal, No Serviceable Parts
17	25151.0008	1	Shield, Insulator
18	36938.0001	1	Top Cover, Front
	01315.0005	4	Screw, Truss Head BLK #8-32 x .38"
19	36944.0000	1	Bracket
	01315.0005	1	Screw, Truss Head BLK #8-32 x .38"
20	42442.1001	1	Panel w/Decals, Access (Includes items 16 & 21)
	01315.0005	4	Screw, Truss Head BLK #8-32 x .38"
21	37921.0002	1	Electrical Schematic 120V
22	34472.0000	1	Lock Assembly (Includes Keys)
	28095.0000	1	Key Set
23	37589.0003	1	Panel, Right Side
	01315.0005	10	Screw, Truss Head BLK #8-32 x .38"
24	37846.1000	1	Drip Tray
25	38185.1000	1	Cover Assy, Drip Tray (Includes item 29)
26	38047.1000	1	Cup Locator Ring
27	29504.0004	1	Screw, Shoulder #8-32 x .38" Lkg
28	36149.0000	2	Fastener
29	12249.1002	1	Guide Rail Kit (Includes nuts)(Optional Equipment)

* Indicates the part number listed is for reference only. See DESCRIPTION for possible service replacement.

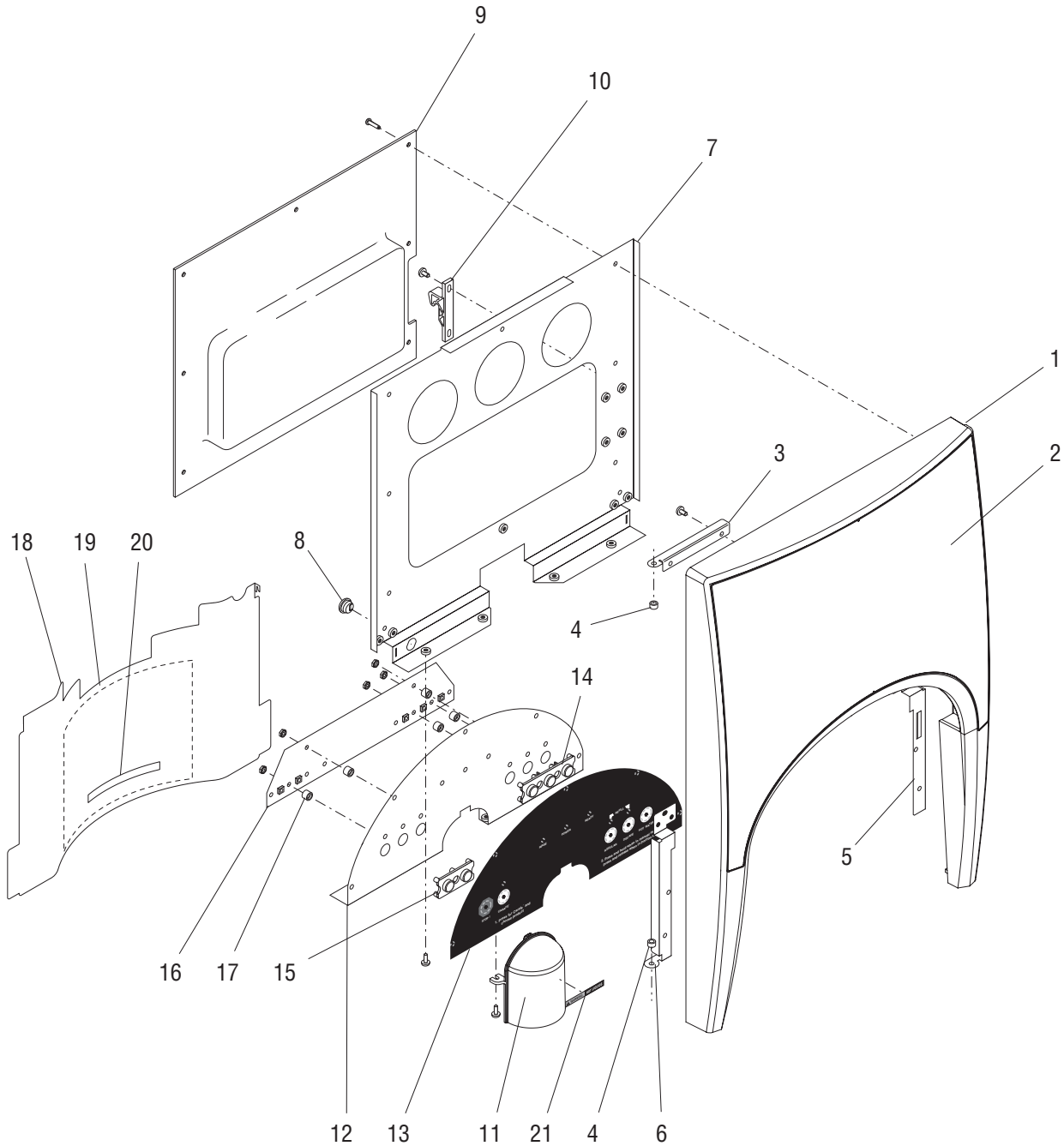

DOOR ASSEMBLY

ITEM	PART NO.	QTY.	DESCRIPTION
-	37826.1004	1	Door Assembly (Includes items 1 - 17 & 22)
1	37438.1002	1	Door w/Decals (Includes item 2)
2	37833.0001	1	Decal, Door Graphic
3	38072.0000	1	Hinge, Top Door
	44224.0000	2	Screw, Pan Head, Phillips #6-20 x .38"
4	37825.0000	2	Spacer
5	37690.0000	1	Bracket, Door Lock Right
	38838.0000	4	Screw, Pan Head, Phillips #6 x .625"
	01382.0000	1	Screw, Truss Head #8 x .38"
6	37446.0000	1	Hinge, Bottom Door
	38838.0000	4	Screw, Pan Head, Phillips #6 x .625"
	01382.0000	1	Screw, Truss Head #8 x .38"
7	37442.0001	1	Bracket, Door Support
8	04822.0000	1	Bushing, Strain Relief
9	38795.0000	1	Liner, Inner Door
	38838.0000	7	Screw, Pan Head, Phillips #6 x .625"
	01382.0000	1	Screw, Truss Head #8 x .38"
10	34667.0000	1	Keeper, Door Latch
	01315.0000	2	Screw, Truss Head #8 x .38"
11	38794.1000	1	Cover W/Decal, Dispense Nozzle (Includes item 21)
	21717.0000	2	Screw, Pan Head, Std #6-32 x .375"
12	37440.1000	1	Panel w/Decals (Includes item 13)
	44224.0000	5	Screw, Pan Head, Phillips #6-20 x .38"
	01382.0000	4	Screw, Truss Head #8 x .38"
13	37585.0000	1	Decal, Control Panel
14	34387.0001	1	Cover, Push Button 3 Switch
15	34387.0000	1	Cover, Push Button 2 Switch
16	39008.1000	1	Circuit Board
17	37828.0000	5	Spacer
	00970.0000	5	Nut, Keps #8-32
18	37444.1001	1	Panel, Splash w/Decals (Includes items 19 & 21)
	38838.0000	2	Screw, Pan Head, Phillips #6 x .625"
19	38792.0000	1	Decal, Cleaning
20	11646.0002	1	Decal, Warning - Hot Liquid (English/French)
21	37280.0000	1	Decal, Warning - Hot Liquid
22	37916.0000	1	Wiring Harness, Door Interconnect (Not illustrated)

* Indicates the part number listed is for reference only. See DESCRIPTION for possible service replacement.

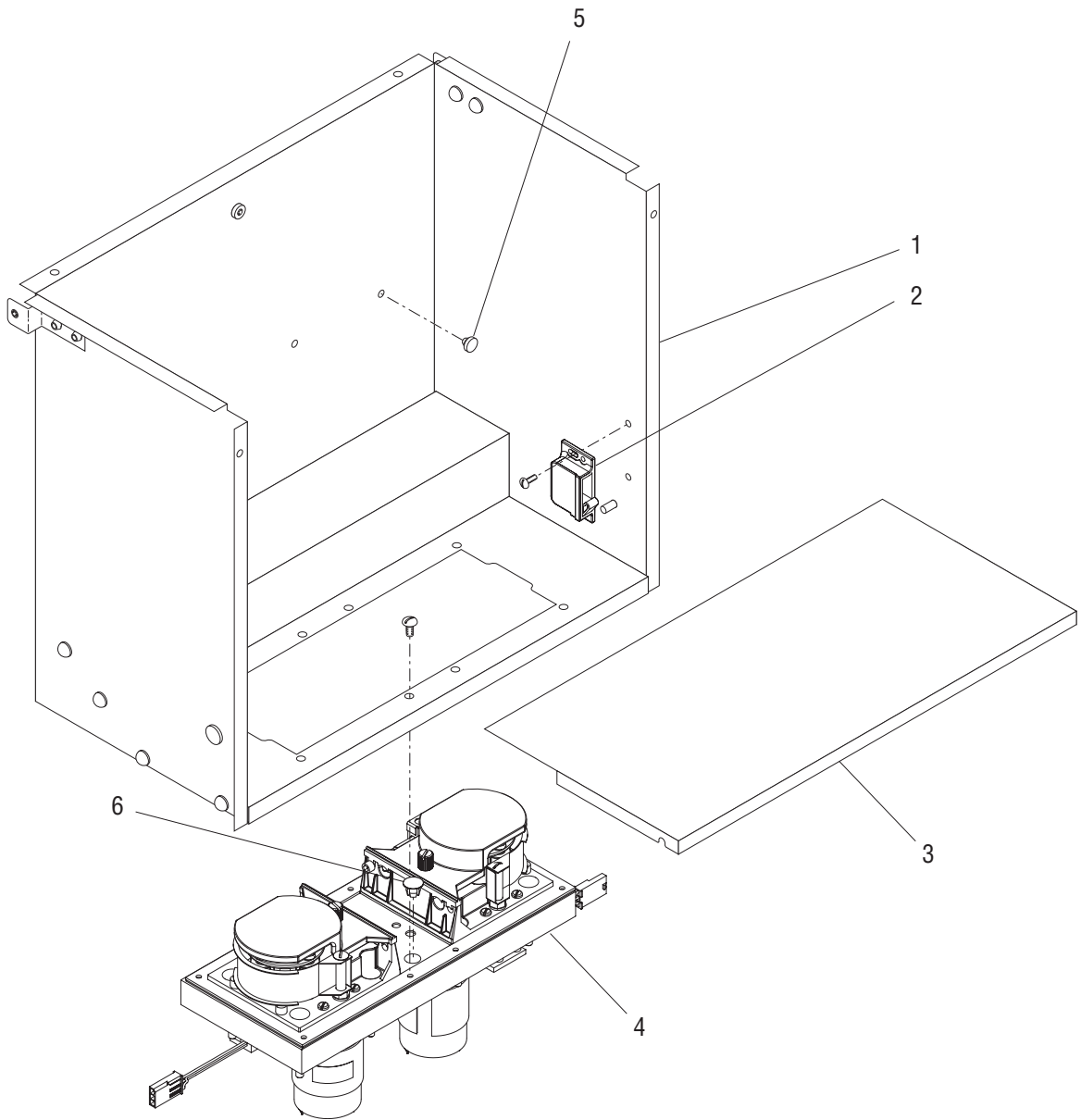

CABINET ASSEMBLY

ITEM	PART NO.	QTY.	DESCRIPTION
1	38785.1000	1	Cabinet Assy (Includes item 2)
2	34666.0001	1	Catch, Door Latch
	48817.0000	2	Screw, Pan Head #4-40 x .50"
3	38793.0001*	1	Platform, Product
4	-----	1	Pump Assy (See PUMP ASSEMBLY)
	01315.0000	8	Screw, Truss Head #8 x .38"
5	34340.1000	1	Button Kit (Includes 4 Buttons)
6	40204.0000	1	Plug

* Indicates the part number listed is for reference only. See DESCRIPTION for possible service replacement.

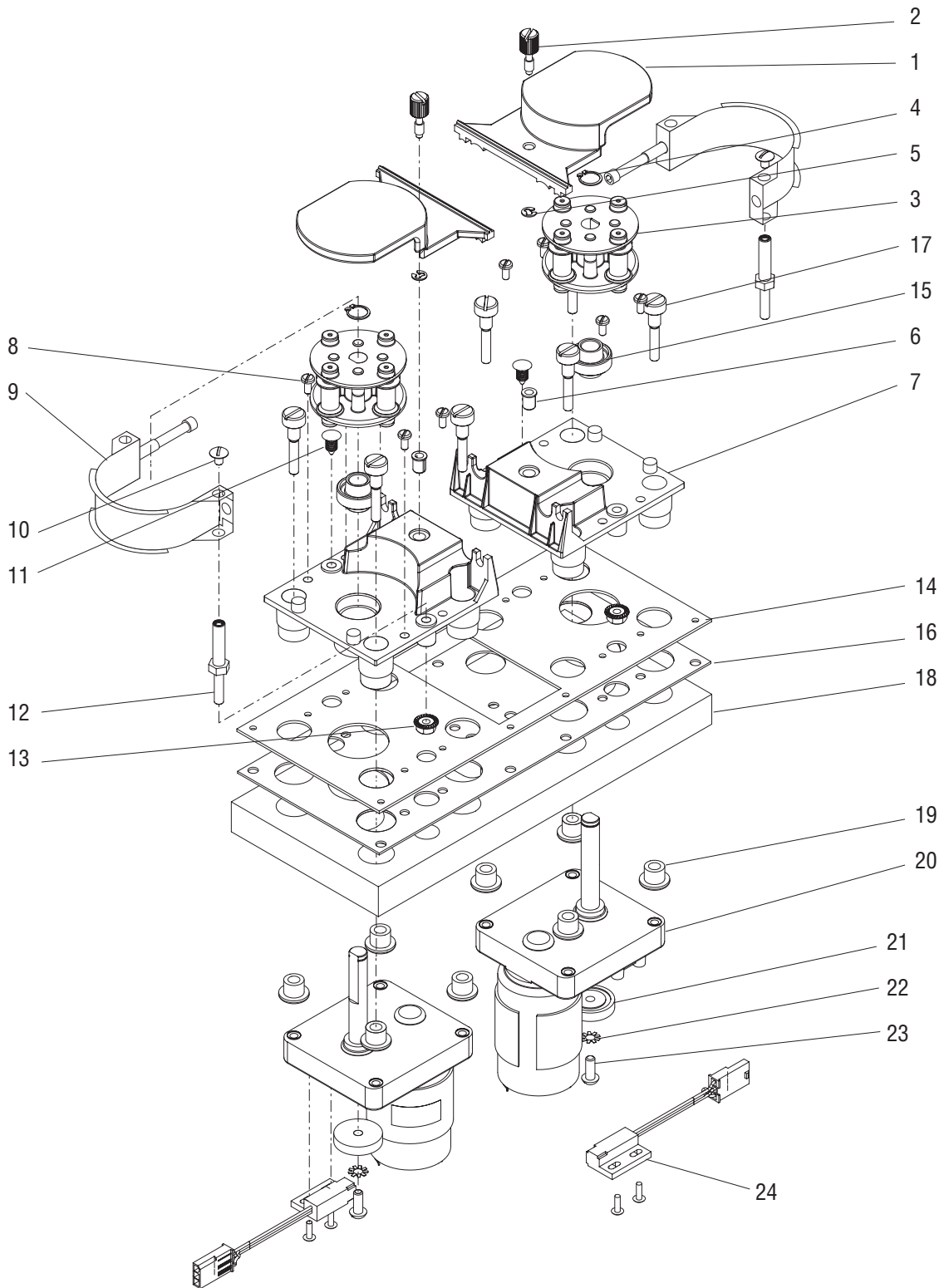

PUMP ASSEMBLY

ITEM	PART NO.	QTY.	DESCRIPTION
-	37829.1000	1	Pump Assy (Includes items 1 thru 24)
1	34167.0000	2	Cover, Pump Block
2	34997.0000	2	Thumb Screw
3	32706.1000	2	Rotor
4	32652.0000	2	Retaining Ring
5	34998.0000	2	Retaining Ring
6	32928.0000	2	Insert, Threaded
7	34166.1002	2	Block Assy, Pump (Includes items 6 & 15)
8	02328.0003	8	Screw, Pan Head #6-32 x .312"
9	40030.1000	2	Compression Band Assy
10	01311.0001	2	Screw, Truss Head #8-32 x .25" Locking
11	36149.0000	2	Fastener
12	32609.0000	2	Standoff
13	34765.0000	2	Nut, Flanged #10-32
14	40050.0001	1	Gasket
15	33825.0000	2	Bearing
16	36928.0000	1	Bracket, Pump Mounting
17	32927.0000	8	Screw, Shoulder #10-32 UNC
18	37580.0000	1	Insulation, Pump
19	32957.0000	8	Bushing
20	34536.0001	2	Motor
21	32654.0000	2	Magnet Hub
22	01512.0000	2	Lockwasher, External-tooth #10
23	01331.0004	2	Screw, Round Head, Locking #10-32
24	33608.1000	2	Sensor, RPM
	02336.0000	4	Screw, Truss Head #4-40 x .38"
25	00617.0000	1	Cable Tie (Not Illustrated)

* Indicates the part number listed is for reference only. See DESCRIPTION for possible service replacement.

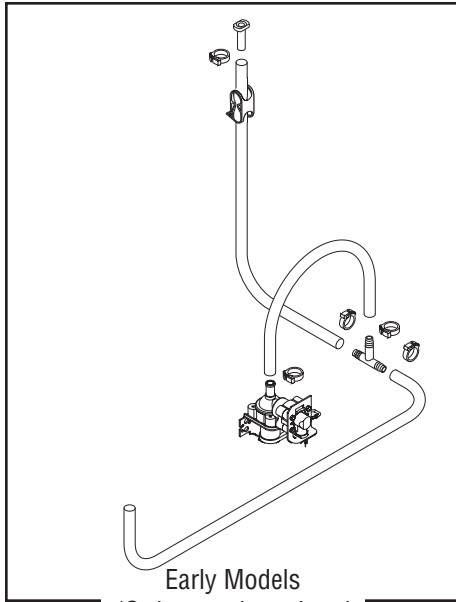

Early Models
(Order new item 4 and
re-configure as shown)

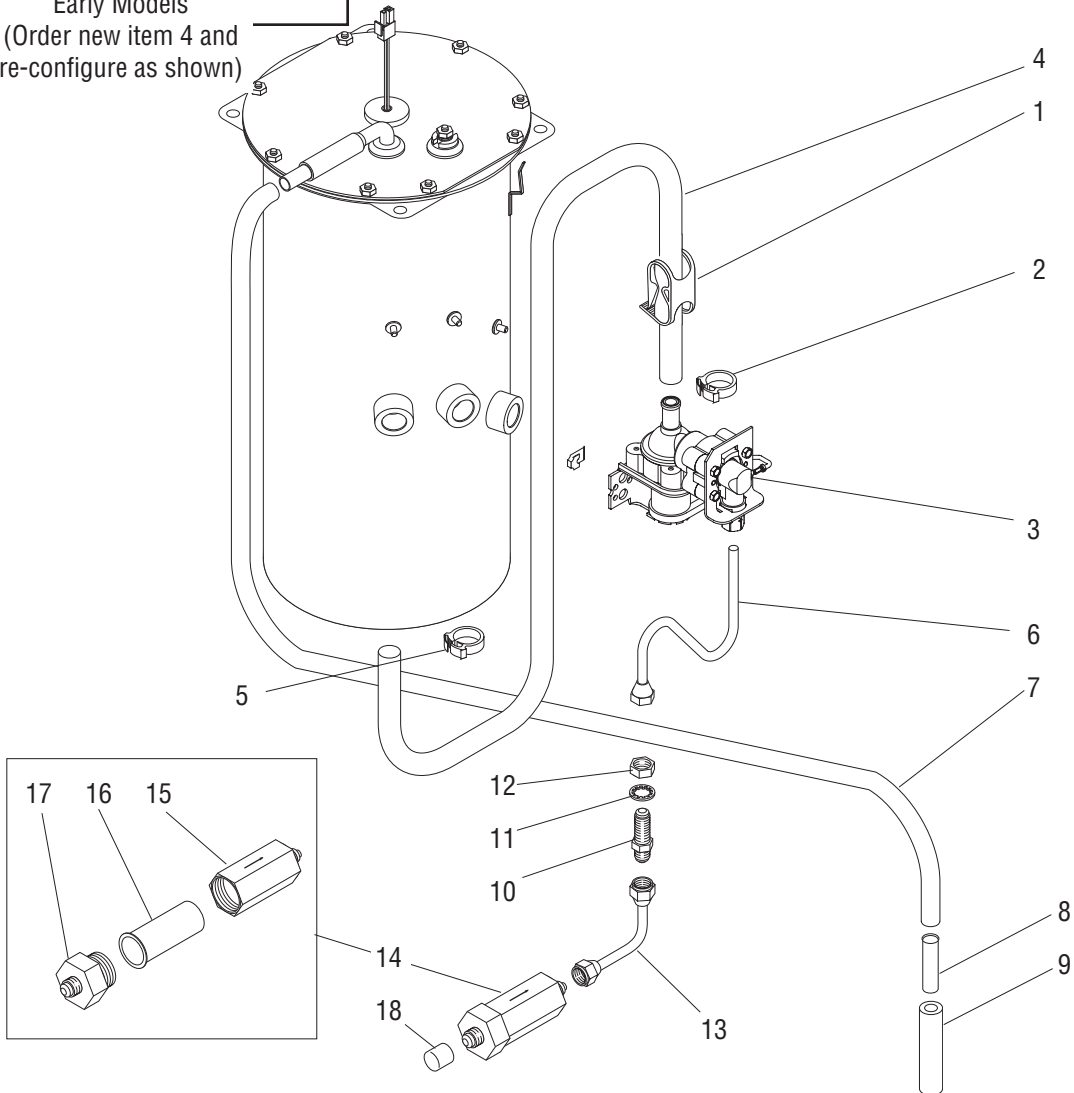

WATER INLET & TANK DRAIN (Early Models)

ITEM	PART NO.	QTY.	DESCRIPTION
1	11630.0001	1	Clamp, Shut off
2	12422.0001	1	Clamp .59/.66" ID
3	26135.0005	1	Valve (Horton), Water Inlet 120V
	26135.0006	1	Valve (Horton), Water Inlet 208-240V
	01315.0005	2	Screw, Truss Head BLK #8-32 x .38"
	00938.0000	2	Fastener, U-type #8-32
4	28526.0000*	1	Tube, Silicone .313" ID x 11.5" (Order item 19)
5	12422.0006	1	Clamp .53/.59" ID
6	26661.0000	1	Tube, Water Inlet
7	28526.0009*	1	Tube, Silicone .313" ID x 24.0" (Order item 19)
8	21801.0002	1	Tube, SST .375" O.D. x 1.50"
9	28526.0029*	1	Tube, Silicone .313" I.D. x .50" (Order item 19)
10	00459.0000	1	Fitting, Bulkhead
11	01532.0000	1	Lockwasher, Internal tooth .438"
12	00463.0000	1	Nut, Hex .438"-20
13	21814.0016	1	Tube
14	23820.1000	1	Strainer Assy (Includes items 15 - 17)
15	23819.0000*	1	Body (Order item 14)
16	23721.0000	1	Screen
17	22249.0000	1	Cap, End
18	12919.0005	1	Cap (For shipping purposes only)
19	28526.1000	-	Tube, Silicone .313" ID x 12.0" (Use as required)
	28526.1001	-	Tube, Silicone .313" ID x 36.0" (Use as required)
	28526.1002	-	Tube, Silicone .313" ID x 60.0" (Use as required)
	28526.1003	-	Tube, Silicone .313" ID x 120.0" (Use as required)

* Indicates the part number listed is for reference only. See DESCRIPTION for possible service replacement.

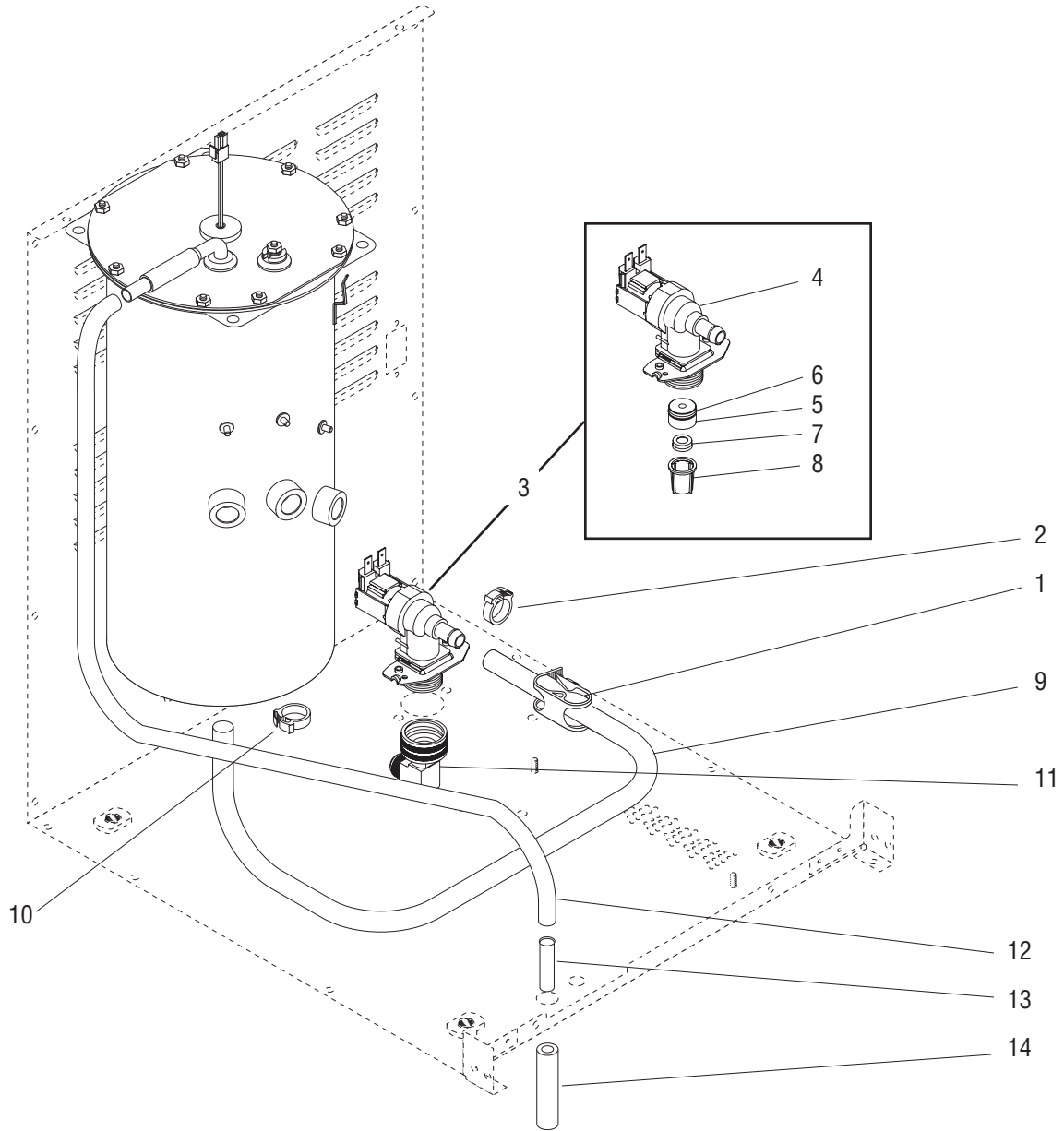

WATER INLET & TANK DRAIN (Late Models)

ITEM	PART NO.	QTY.	DESCRIPTION
1	11630.0001	1	Clamp, Shut off
2	12422.0001	1	Clamp .59/.66" ID
3	40506.0006	1	Valve (Eltek), Water Inlet 120V (Includes items 4 thru 8)
	40506.0007	1	Valve (Eltek), Water Inlet 208-240V (Includes items 4 thru 8)
	32283.0000	2	Screw, Pan Head BLK M4 x .6mm
4	36233.0000	1	Valve 120V
	36233.0001	1	Valve 240V
5	40056.0004	1	Housing, Flow Control
6	33725.0000	1	O-ring
7	37857.1750	1	Flow Control
8	-----	1	Screen
9	28526.0000*	1	Tube, Silicone .313" ID x 11.5" (Order item 15)
10	12422.0006	1	Clamp .53/.59" ID
11	37297.0006	1	Fitting, Elbow .375" FI
12	28526.0009*	1	Tube, Silicone .313" ID x 24.0" (Order item 15)
13	21801.0002	1	Tube, SST .375" O.D. x 1.50"
14	28526.0029*	1	Tube, Silicone .313" I.D. x .50" (Order item 15)
15	28526.1000	-	Tube, Silicone .313" ID x 12.0" (Use as required)
	28526.1001	-	Tube, Silicone .313" ID x 36.0" (Use as required)
	28526.1002	-	Tube, Silicone .313" ID x 60.0" (Use as required)
	28526.1003	-	Tube, Silicone .313" ID x 120.0" (Use as required)

* Indicates the part number listed is for reference only. See DESCRIPTION for possible service replacement.

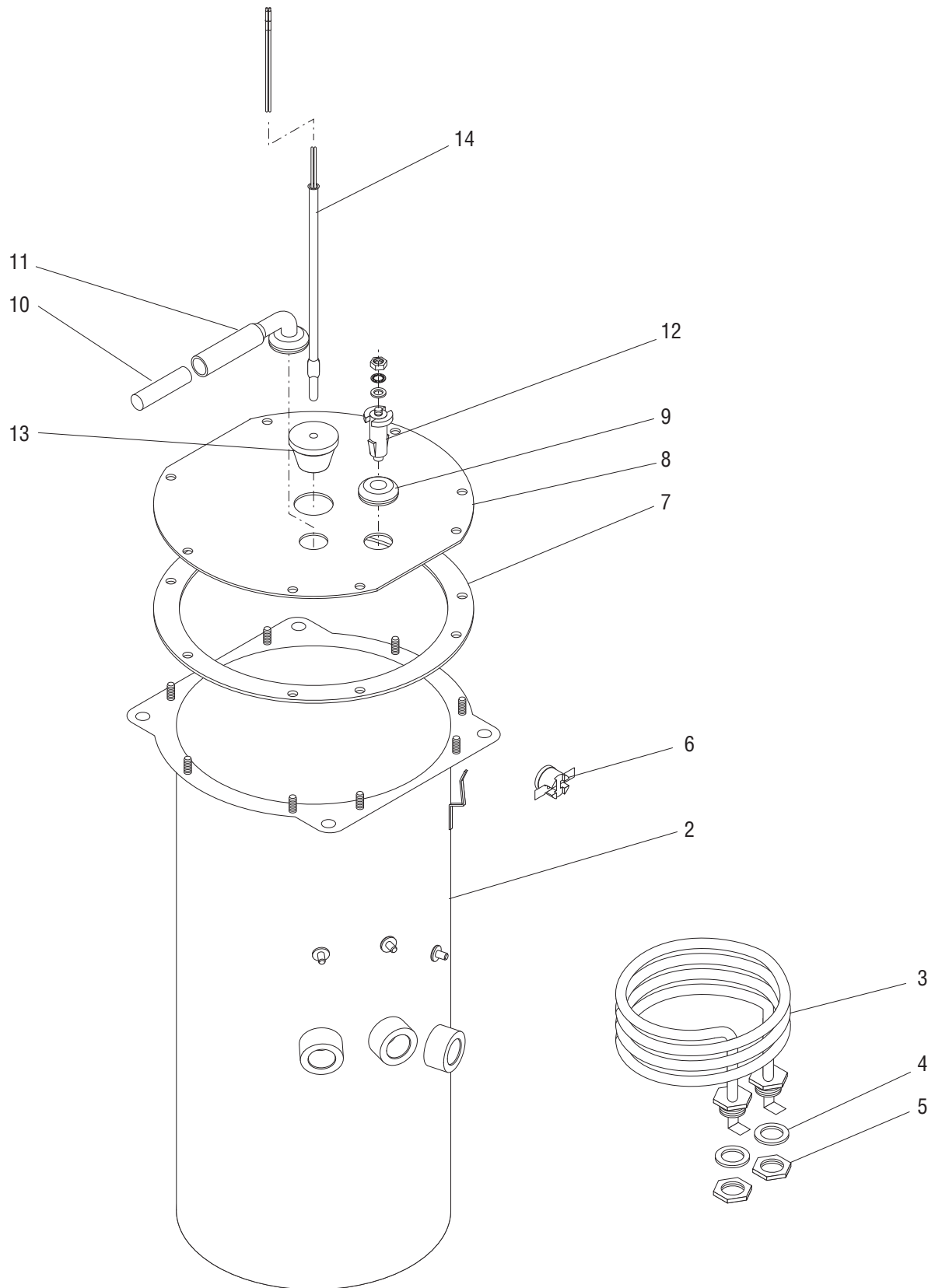

TANK ASSEMBLY

ITEM	PART NO.	QTY.	DESCRIPTION
-	37812.1000	1	Tank Assy 120V (Includes item 1 - 14)
	00970.0000	3	Nut, Keps #8-32
1	36934.0000	1	Insulation, Tank (Not illustrated)
2	36931.0000	1	Tank
3	02755.1000	1	Tank Heater 1425W, 120V (Includes item 4)
4	00943.0000	2	Gasket
5	00942.0000	2	Nut, Hex .50"-20
6	29329.0001	1	Limit Thermostat
7	04221.0000	1	Gasket, Tank Lid
8	28735.0000	1	Tank Lid
	00908.0000	8	Nut, Hex #8-32
9	02536.0000	1	Grommet
10	21801.0002	1	Tube, SST .375" O.D. x 1.50"
11	38969.0001	1	Fitting, Air Vent
12	07412.1002	1	Probe Kit, Liquid Level (Includes hardware below)
	00908.0000	1	Nut, Hex #8-32
	20203.0100	1	Lockwasher, Internal tooth #8
	01501.0000	1	Washer
13	33801.0003	1	Grommet
14	41179.1000	1	Probe, Temperature

* Indicates the part number listed is for reference only. See DESCRIPTION for possible service replacement.

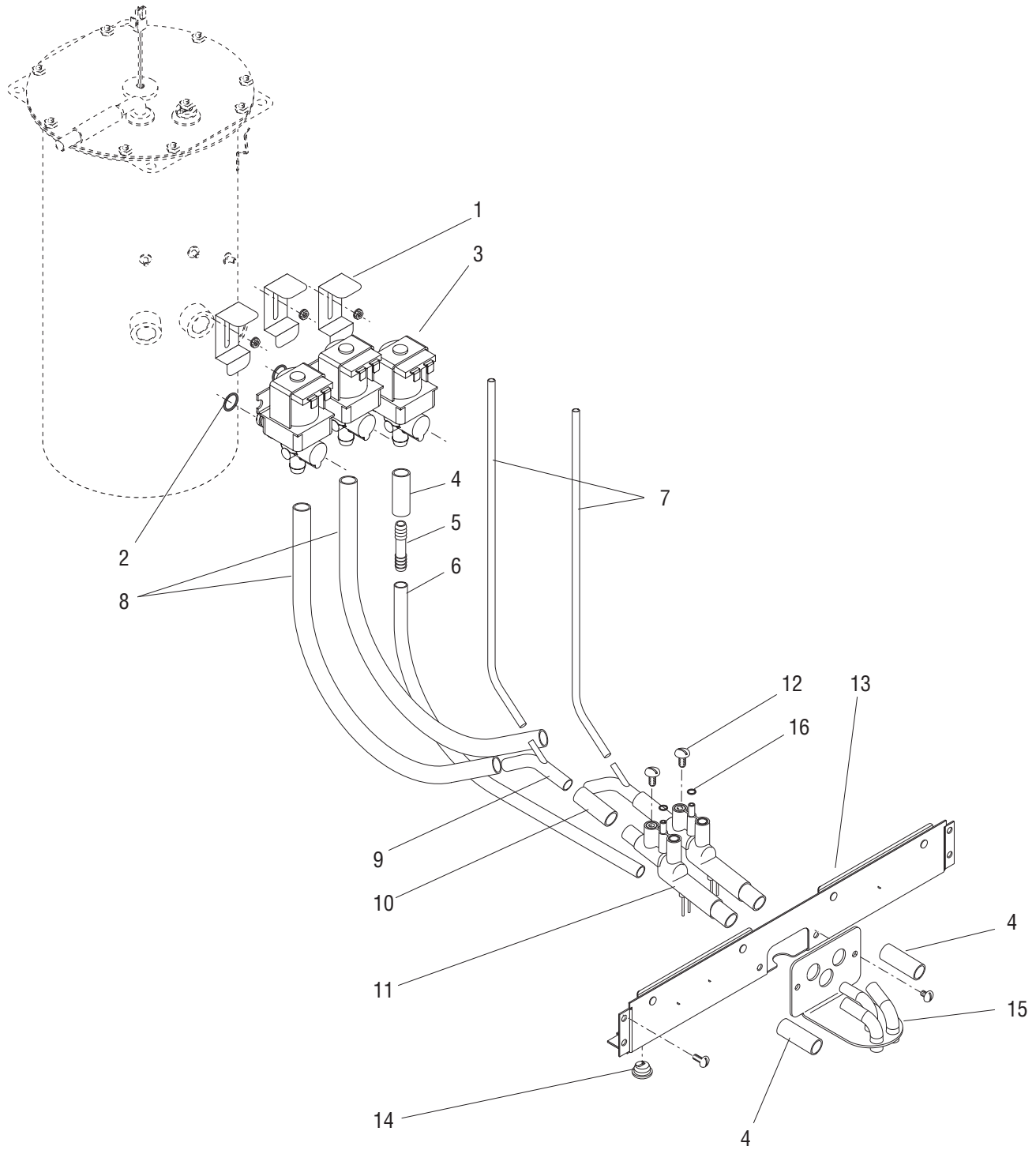

DISPENSE VALVE & MIXING CHAMBER

ITEM	PART NO.	QTY.	DESCRIPTION
1	29576.0000	3	Bracket, Valve Retaining
	00970.0000	3	Nut, Keps #8-32
2	24733.0011	3	O-ring
3	32345.1000	3	Valve, Dispense 120V
4	20976.0062*	3	Tube, Silicone .375" ID x 1.75" (Order item 17)
5	34644.0000	1	Connector
6	11707.0010*	1	Tube, Silicone .25" ID x 16.0" (Order item 18)
7	36630.0001*	2	Tube, Silicone .125" ID x 20.0" (Order item 19)
8	28526.0000*	2	Tube, Silicone .313" ID x 11.5" (Order item 20)
9	37858.0000	2	Elbow, 45°
10	20976.0072*	2	Tube, Silicone .375" ID x 1.5" (Order item 17)
11	37854.1000	2	Mixing Chamber Assy (Includes item 16)
12	01326.0000	2	Screw, Truss Head #10-32 x .25"
13	38786.0000	1	Bracket, Lower Cabinet
	01315.0005	4	Screw, Truss Head BLK #8-32 x .38"
14	04822.0000	1	Bushing, Strain Relief
15	37807.0000	1	Bracket, Dispense Nozzle
	01315.0000	2	Screw, Truss Head #8-32 x .375"
16	40188.0000	2	O-ring
17	20976.1000	-	Tube, Silicone .375" ID x 12.0" (Use as required)
	20976.1001	-	Tube, Silicone .375" ID x 36.0" (Use as required)
	20976.1002	-	Tube, Silicone .375" ID x 120.0" (Use as required)
18	11707.1000	-	Tube, Silicone .25" ID x 12.0" (Use as required)
	11707.1001	-	Tube, Silicone .25" ID x 36.0" (Use as required)
	11707.1002	-	Tube, Silicone .25" ID x 120.0" (Use as required)
19	36630.1001	-	Tube, Silicone .125" ID x 36.0" (Use as required)
20	28526.1000	-	Tube, Silicone .313" ID x 12.0" (Use as required)
	28526.1001	-	Tube, Silicone .313" ID x 36.0" (Use as required)
	28526.1002	-	Tube, Silicone .313" ID x 60.0" (Use as required)
	28526.1003	-	Tube, Silicone .313" ID x 120.0" (Use as required)

* Indicates the part number listed is for reference only. See DESCRIPTION for possible service replacement.

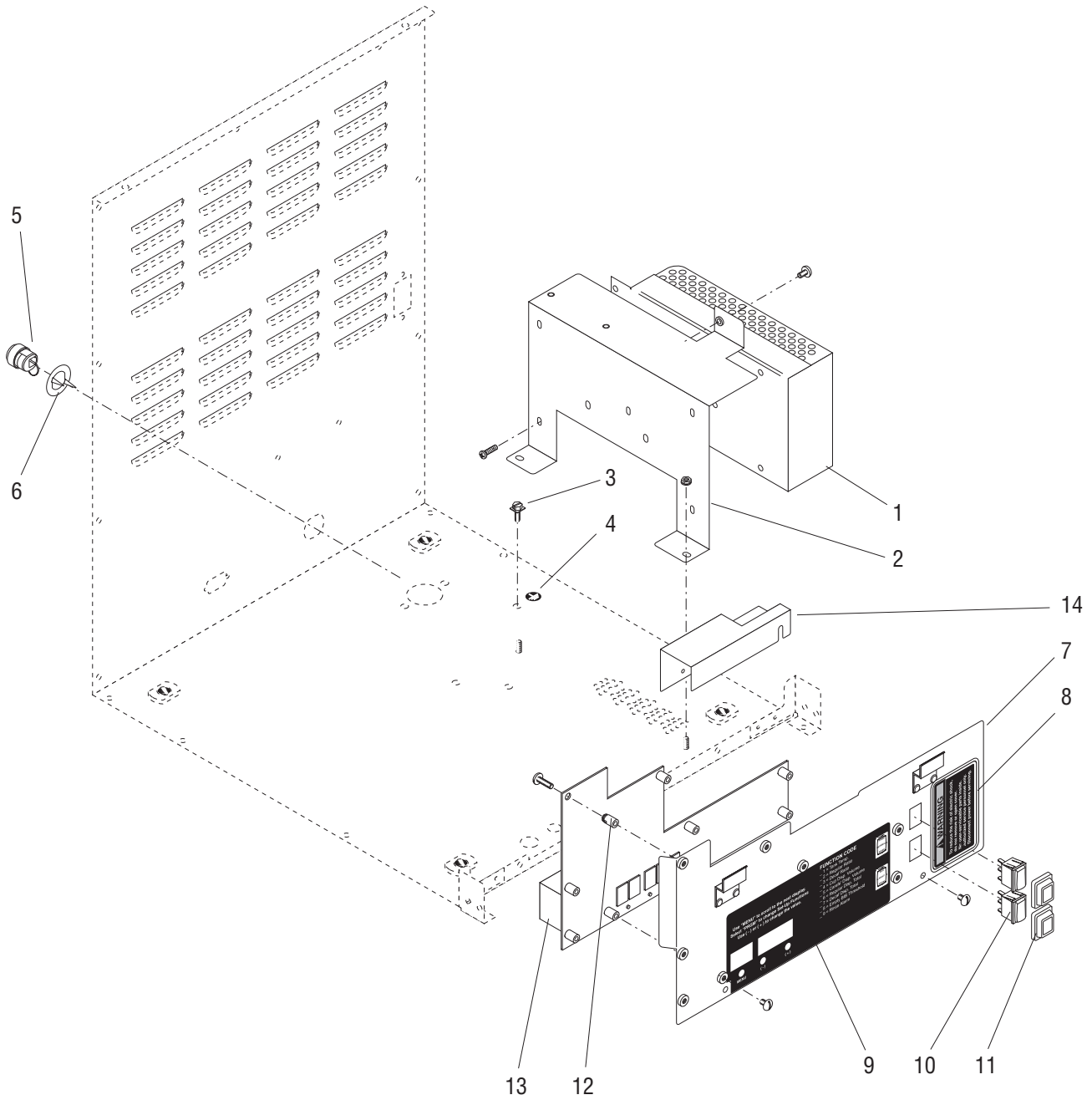

ELECTRICAL COMPONENTS

ITEM	PART NO.	QTY.	DESCRIPTION
1	33363.0004	1	Power Supply Module
	32283.0000	3	Screw, Pan Head M4 x 6.0 mm
2	37851.0000	1	Bracket
	00970.0000	2	Nut, Keps #8-32
	01315.0005	1	Screw, Truss Head BLK #8-32 x .38"
3	01309.0000	1	Screw, Grounding 120V
4	00824.0002	1	Decal, Ground Screw
5	00713.0000	1	Bushing, Strain Relief 120V
6	00715.0000	1	Adapter Washer, Strain Relief 120V
7	38771.1000	1	Bracket w/Decals, Circuit Board Mounting (Includes items 8 & 9)
	01311.0000	2	Screw, Truss Head #8-32 x .25"
8	37881.0000	1	Decal, No Serviceable Parts
9	37911.0001	1	Decal, Main Circuit Board Panel
10	27437.0001	2	Switch
11	34390.0000	2	Cap, Rocker Switch
12	29081.0001	8	Spacer
13	38726.1007	1	Circuit Board, Main
	01390.0000	7	Screw, Round Head #8-32 x .62"
14	46353.1001	1	Shield Kit
Items listed below are not illustrated			
15	37775.0000	1	Wiring Harness, Main 120V
16	20630.0008	1	Power Cord 120V
17	00603.0000	1	Clamp
	01370.0000	1	Screw, Pan Head, Slt'd 8-32 x .75"
18	00617.0000	1	Cable Tie

* Indicates the part number listed is for reference only. See DESCRIPTION for possible service replacement.

NUMERICAL INDEX

PART NO.	PAGE NO.	PART NO.	PAGE NO.	PART NO.	PAGE NO.	PART NO.	PAGE NO.
00459.0000	13	21814.0016	13	36233.0001	15	38969.0001	17
00463.0000	13	22249.0000	13	36398.0000	5	39008.1000	7
00603.0000	21	23721.0000	13	36630.0001	19	40030.1000	11
00617.0000	11,21	23819.0000	13	36630.1001	19	40050.0001	11
00656.0000	5	23820.1000	13	36928.0000	11	40056.0004	15
00713.0000	21	24733.0011	19	36931.0000	17	40188.0000	19
00715.0000	21	25151.0008	5	36934.0000	17	40204.0000	9
00824.0000	5,21	26135.0005	13	36938.0001	5	40506.0006	15
00908.0000	17	26135.0006	13	36941.0000	5	40506.0007	15
00938.0000	13	26528.0000	5	36944.0000	5	41179.1000	17
00942.0000	17	26661.0000	13	36945.1000	5	41321.1000	5
00943.0000	17	27437.0001	21	37280.0000	7	42442.1001	5
00970.0000	7,17,19,21	28095.0000	5	37297.0006	15	44224.0000	7
00986.0002	5	28526.0000	13,15,17	37438.1002	7	46353.1001	21
01309.0000	21	28526.0029	13,15	37440.1000	7	48817.0000	9
01311.0000	21	28526.1000	13,15,19	37442.0001	7		
01311.0001	11	28526.1001	13,15,19	37444.1001	7		
01315.0000	7,9,19	28526.1002	13,15,19	37446.0000	7		
01315.0005	5,13,19,21	28526.1003	13,15,19	37578.0001	5		
01326.0000	19	28735.0000	17	37580.0000	11		
01331.0004	11	29081.0001	21	37585.0000	7		
01370.0000	21	29329.0001	17	37589.0003	5		
01382.0000	7	29504.0004	5	37690.0000	7		
01390.0000	21	29576.0000	19	37708.0003	5		
01501.0000	17	32283.0000	15,21	37716.0001	5		
01512.0000	11	32345.1000	19	37775.0000	21		
01526.0001	5	32609.0000	11	37807.0000	19		
01532.0000	13	32652.0000	11	37812.1000	17		
02328.0003	11	32654.0000	11	37825.0000	7		
02336.0000	11	32706.1000	11	37826.1004	7		
02536.0000	17	32927.0000	11	37828.0000	7		
02755.1000	17	32928.0000	11	37829.1000	11		
03996.0000	5	32957.0000	11	37833.0001	7		
04221.0000	17	33363.0004	21	37846.1000	5		
04822.0000	7,19	33608.1000	11	37851.0000	21		
07412.1002	17	33725.0000	15	37854.1000	19		
11630.0001	13,15	33801.0003	17	37857.1750	15		
11646.0002	7	33825.0000	11	37858.0000	19		
11707.0010	19	34118.0001	5	37881.0000	5,21		
11707.1000	19	34166.1002	11	37911.0001	21		
11707.1001	19	34167.0000	11	37916.0000	7		
11707.1002	19	34340.1000	9	37921.0002	5		
12249.1002	5	34387.0000	7	38047.1000	5		
12422.0001	13,15	34387.0001	7	38072.0000	7		
12422.0006	13,15	34390.0000	21	38185.1000	5		
12919.0005	13	34472.0000	5	38276.1007	21		
20203.0100	17	34536.0001	11	38771.1000	21		
20630.0008	21	34644.0000	19	38774.1000	5		
20976.0062	19	34666.0001	9	38785.1000	9		
20976.0072	19	34667.0000	7	38786.0000	19		
20976.1000	19	34765.0000	11	38792.0000	7		
20976.1001	19	34997.0000	11	38793.0001	9		
20976.1002	19	34998.0000	11	38794.1000	7		
21717.0000	7	36149.0000	5,11	38795.0000	7		
21801.0002	13,15,17	36233.0000	15	38838.0000	7		