

# BUNN®

**DUAL®**  
(Serial # DUAL010000 - Up)

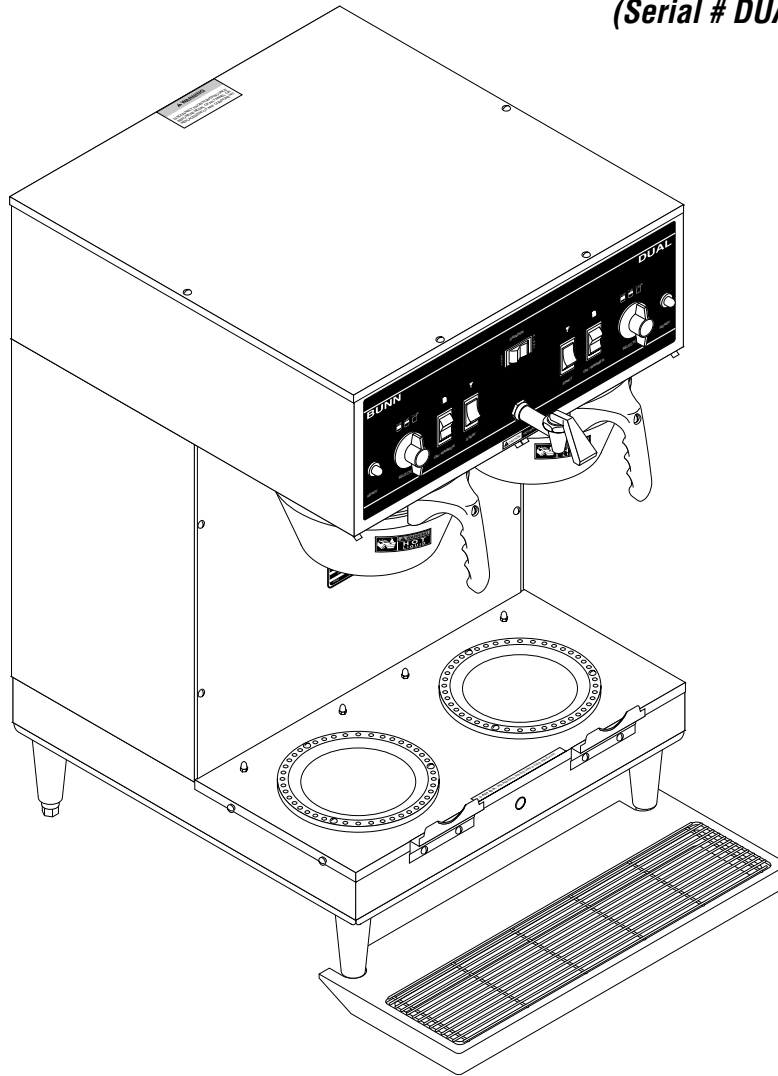

## INSTALLATION & OPERATING GUIDE

### BUNN-O-MATIC CORPORATION

POST OFFICE BOX 3227

SPRINGFIELD, ILLINOIS 62708-3227

PHONE: (217) 529-6601 FAX: (217) 529-6644

To ensure you have the latest revision of the manual or to obtain the illustrated parts catalog, please visit the Bunn-O-Matic website, at [www.bunn.com](http://www.bunn.com). This is absolutely FREE, and the quickest way to obtain the latest catalog and manual updates. Contact Bunn-O-Matic Corporation at 1-800-286-6070 to obtain a paper copy of the required Illustrated Parts Catalog mailed via U.S. Postal Service.



## **BUNN-O-MATIC COMMERCIAL PRODUCT WARRANTY**

Bunn-O-Matic Corp. ("BUNN") warrants equipment manufactured by it as follows:

- 1) Airpots, thermal carafes, decanters, GPR servers, iced tea/coffee dispensers, MCP/MCA pod brewers thermal servers and ThermoFresh servers (mechanical and digital)- 1 year parts and 1 year labor.
- 2) All other equipment - 2 years parts and 1 year labor plus added warranties as specified below:
  - a) Electronic circuit and/or control boards - parts and labor for 3 years.
  - b) Compressors on refrigeration equipment - 5 years parts and 1 year labor.
  - c) Grinding burrs on coffee grinding equipment to grind coffee to meet original factory screen sieve analysis - parts and labor for 4 years or 40,000 pounds of coffee, whichever comes first.

These warranty periods run from the date of installation BUNN warrants that the equipment manufactured by it will be commercially free of defects in material and workmanship existing at the time of manufacture and appearing within the applicable warranty period. This warranty does not apply to any equipment, component or part that was not manufactured by BUNN or that, in BUNN's judgment, has been affected by misuse, neglect, alteration, improper installation or operation, improper maintenance or repair, non periodic cleaning and descaling, equipment failures related to poor water quality, damage or casualty. In addition, the warranty does not apply to replacement of items subject to normal use including but not limited to user replaceable parts such as seals and gaskets. This warranty is conditioned on the Buyer 1) giving BUNN prompt notice of any claim to be made under this warranty by telephone at (217) 529-6601 or by writing to Post Office Box 3227, Springfield, Illinois 62708-3227; 2) if requested by BUNN, shipping the defective equipment prepaid to an authorized BUNN service location; and 3) receiving prior authorization from BUNN that the defective equipment is under warranty.

**THE FOREGOING WARRANTY IS EXCLUSIVE AND IS IN LIEU OF ANY OTHER WARRANTY, WRITTEN OR ORAL, EXPRESS OR IMPLIED, INCLUDING, BUT NOT LIMITED TO, ANY IMPLIED WARRANTY OF EITHER MERCHANTABILITY OR FITNESS FOR A PARTICULAR PURPOSE.** The agents, dealers or employees of BUNN are not authorized to make modifications to this warranty or to make additional warranties that are binding on BUNN. Accordingly, statements by such individuals, whether oral or written, do not constitute warranties and should not be relied upon.

If BUNN determines in its sole discretion that the equipment does not conform to the warranty, BUNN, at its exclusive option while the equipment is under warranty, shall either 1) provide at no charge replacement parts and/or labor (during the applicable parts and labor warranty periods specified above) to repair the defective components, provided that this repair is done by a BUNN Authorized Service Representative; or 2) shall replace the equipment or refund the purchase price for the equipment.

**THE BUYER'S REMEDY AGAINST BUNN FOR THE BREACH OF ANY OBLIGATION ARISING OUT OF THE SALE OF THIS EQUIPMENT, WHETHER DERIVED FROM WARRANTY OR OTHERWISE, SHALL BE LIMITED, AT BUNN'S SOLE OPTION AS SPECIFIED HEREIN, TO REPAIR, REPLACEMENT OR REFUND.**

In no event shall BUNN be liable for any other damage or loss, including, but not limited to, lost profits, lost sales, loss of use of equipment, claims of Buyer's customers, cost of capital, cost of down time, cost of substitute equipment, facilities or services, or any other special, incidental or consequential damages.

392, AutoPOD, AXIOM, BrewLOGIC, BrewMETER, Brew Better Not Bitter, BrewWISE, BrewWIZARD, BUNN Espresso, BUNN Family Gourmet, BUNN Gourmet, BUNN Pour-O-Matic, BUNN, BUNN with the stylized red line, BUNNlink, Bunn-OMatic, Bunn-O-Matic, BUNNserve, BUNNSERVE with the stylized wrench design, Cool Froth, DBC, Dr. Brew stylized Dr. design, Dual, Easy Pour, EasyClear, EasyGard, FlavorGard, Gourmet Ice, Gourmet Juice, High Intensity, iMIX, Infusion Series, Intellisteam, My Café, Phase Brew, PowerLogic, Quality Beverage Equipment Worldwide, Respect Earth, Respect Earth with the stylized leaf and coffee cherry design, Safety-Fresh, savemycoffee.com, Scale-Pro, Silver Series, Single, Smart Funnel, Smart Hopper, SmartWAVE, Soft Heat, SplashGard, The Mark of Quality in Beverage Equipment Worldwide, ThermoFresh, Titan, trifecta, Velocity Brew, A Partner You Can Count On, Air Brew, Air Infusion, Beverage Bar Creator, Beverage Profit Calculator, Brew better, not bitter., BUNNSource, Coffee At Its Best, Cyclonic Heating System, Daypart, Digital Brewer Control, Nothing Brews Like a BUNN, Pouring Profits, Signature Series, Tea At Its Best, The Horizontal Red Line, Ultra are either trademarks or registered trademarks of Bunn-O-Matic Corporation.

# USER NOTICES

The notices on this brewer should be kept in good condition. Replace unreadable or damaged labels.



00658.0000

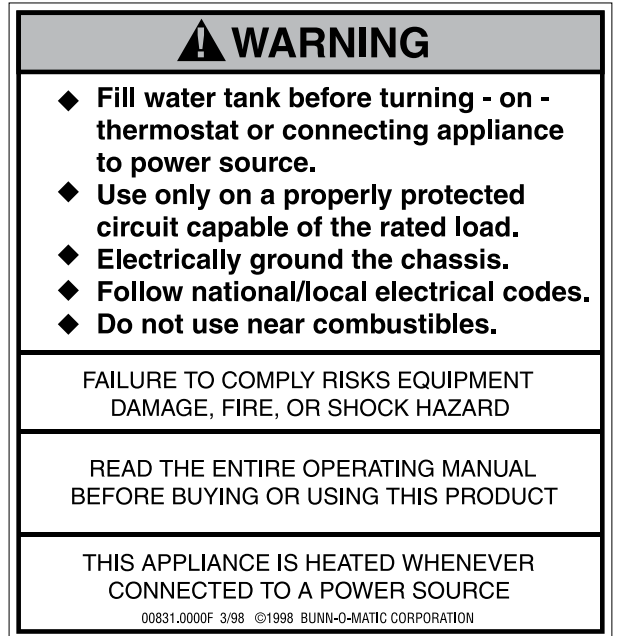

00831.0000

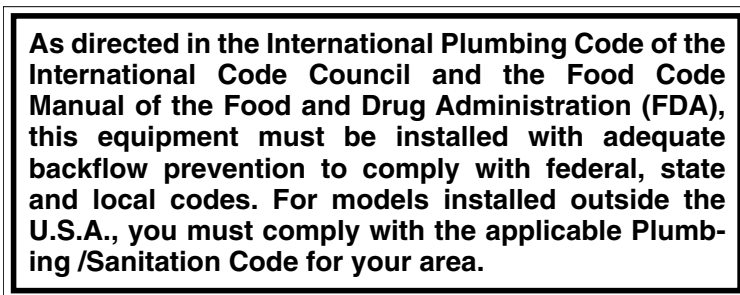

00656.0001

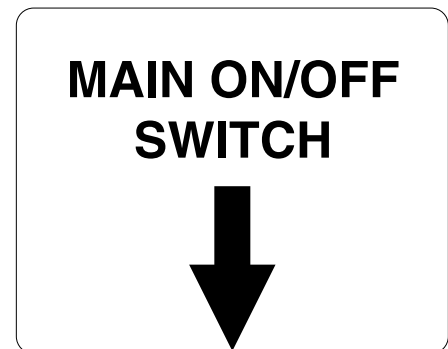

39803.0000

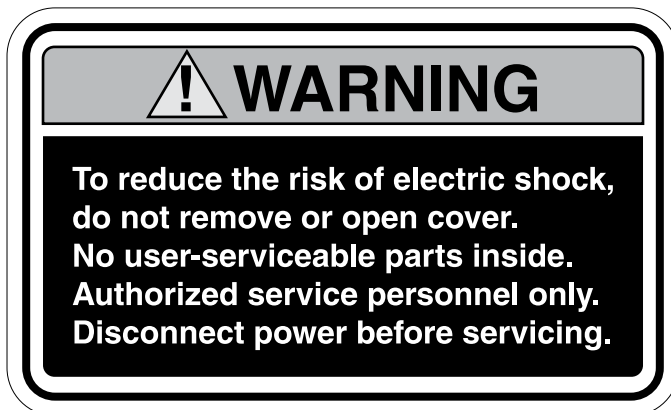

37881.0000



20201.5600



00824.0002



12364.0000

## ELECTRICAL REQUIREMENTS

**WARNING** - The brewer must be disconnected from the power source until specified in *Initial Set-Up*.

Refer to Data Plate on the Brewer, and local/national electrical codes to determine circuit requirements.

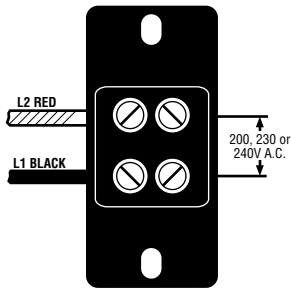

200, 230 & 240 volt ac models

Note: This electrical service consists of 2 current carrying conductors (L1 and L2) and a separate conductor for earth ground.

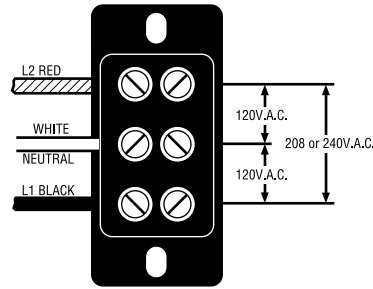

120/208 & 120/240 volt ac models

Note: This electrical service consists of 3 current carrying conductors (Neutral, L1 and L2) and a separate conductor for earth ground.

## Electrical Hook-Up

**CAUTION** – Improper electrical installation will damage electronic components.

1. An electrician must provide electrical service as specified.
2. Using a voltmeter, check the voltage and color coding of each conductor at the electrical source.
3. Remove the front panel beneath the sprayheads.

### Models with electronic control assemblies:

Place the tank heater switch at the top of the control assembly in the “OFF” position.

### Models with electro/mechanical thermostats:

Rotate the control thermostat knob fully counterclockwise to the “OFF” position.

4. Feed the cord through the strain relief and connect it to the terminal block.
5. Connect the brewer to the power source and verify the voltage at the terminal block before proceeding. Replace the front panel.
6. If plumbing is to be hooked up later be sure the brewer is disconnected from the power source. If plumbing has been hooked up, the brewer is ready for Initial Set-Up.

## PLUMBING REQUIREMENTS

This brewer must be connected to a cold water system with operating pressure between 20 and 90 psi (138 and 620 kPa) from a  $\frac{1}{2}$ " or larger supply line. A shut-off valve should be installed in the line before the brewer. Install a regulator in the line when pressure is greater than 90 psi (620 kPa) to reduce it to 50 psi (345 kPa). The water inlet fitting is  $\frac{1}{4}$ " flare.

**NOTE** – Bunn-O-Matic recommends  $\frac{1}{4}$ " copper tubing for installations of less than 25 feet and  $\frac{3}{8}$ " for more than 25 feet from the  $\frac{1}{2}$ " water supply line. A tight coil of copper tubing in the water line will facilitate moving the brewer to clean the countertop. Bunn-O-Matic does not recommend the use of a saddle valve to install the brewer. The size and shape of the hole made in the supply line by this type of device may restrict water flow.

**As directed in the International Plumbing Code of the International Code Council and the Food Code Manual of the Food and Drug Administration (FDA), this equipment must be installed with adequate backflow prevention to comply with federal, state and local codes. For models installed outside the U.S.A., you must comply with the applicable Plumbing /Sanitation Code for your area.**

**NOTE** - If a backflow preventer is required by code, a shock arrestor should be installed between backflow pre-

## Plumbing Hook-Up

venter and dispenser. Installing the shock arrestor as close to dispenser as possible will provide best results.

1. Flush the water line and securely attach it to the flare fitting on the strainer/flow control located on bottom of brewer.
2. Turn on the water supply.

## CE REQUIREMENTS

- This appliance must be installed in locations where it can be overseen by trained personnel.
- For proper operation, this appliance must be installed where the temperature is between 5°C to 35°C.
- Appliance shall not be tilted more than 10° for safe operation.
- An electrician must provide electrical service as specified in conformance with all local and national codes.
- This appliance must not be cleaned by water jet.
- This appliance is not intended for use by persons (including children) with reduced physical, sensory or mental capabilities, or lack of experience and knowledge, unless they have been given instructions concerning use of this appliance by a person responsible for its safety.
- Children should be supervised to ensure they do not play with the appliance.
- If the power cord is ever damaged, it must be replaced by the manufacturer or authorized service personnel with a special cord available from the manufacturer or its authorized service personnel in order to avoid a hazard.

## INITIAL SET-UP

**CAUTION** – The brewer must be disconnected from the power source throughout the initial set-up, except when specified in the instructions.

**NOTE:** ECA Models Only -This brewer is equipped with a temperature sensor that indicates when to brew and, when selected, locks-out the start of a brew cycle until the water has heated to the optimum brewing temperature.

1. Remove the front panel beneath the sprayhead.

**Models with electronic control assemblies:**

Place the tank heater switch at the top of the control assembly in the “OFF” position.

Replace the front panel.

**Models with electro/mechanical thermostats:**

Rotate the control thermostat knob fully counterclockwise to the “OFF” position.

Replace the front panel.

2. Connect the brewer to the power source. Water will begin flowing into the tank.
3. When water stops flowing into the tank, remove the front panel and proceed as directed:

**Models with electronic control assemblies:**

Place the tank heater switch at the top of the control assembly in the “ON” position and replace the front panel.

**Models with electro/mechanical thermostats:**

Rotate the control thermostat knob fully clockwise to the “ON” position and replace the front panel.

4. Wait approximately twenty minutes for the water in the tank to heat to the proper temperature.
5. Place an empty server beneath either brew station and the ON/OFF switch in the upper (“ON”) position.
6. **Triple-set Timers only:** Place the brew station Selector switch in the 1½ gallon position.
7. (A) Initiate a brew cycle; after water has stopped flowing from the funnel, place the ON/OFF switch in the lower (“OFF”) position and check the water volume in the server. It should be 192 ounces (5.7 L) for 1 1/2 gallons. If not, adjust the timer as required. Refer to *Adjusting Brew Volumes*

**NOTE:** Each batch setting must be adjusted individually, if they are not correct. Volumes are as follows:

1 gallon - 128 ounces (3.8L)

.5 gallon - 64 ounces (1.9L)

(B) If necessary adjust the needle valve to achieve desired water volume to be bypassed around the coffee filter in the funnel.

## INITIAL SET-UP (cont.)

### REFERENCE CHART

**MECHANICAL BYPASS WITH ADJUSTABLE NEEDLE VALVE**  
BYPASS PERCENTAGE VS NUMBER OF FULL TURNS FROM  
MAXIMUM CLOCKWISE POSITION  
SINGLE & DUAL BREWERS

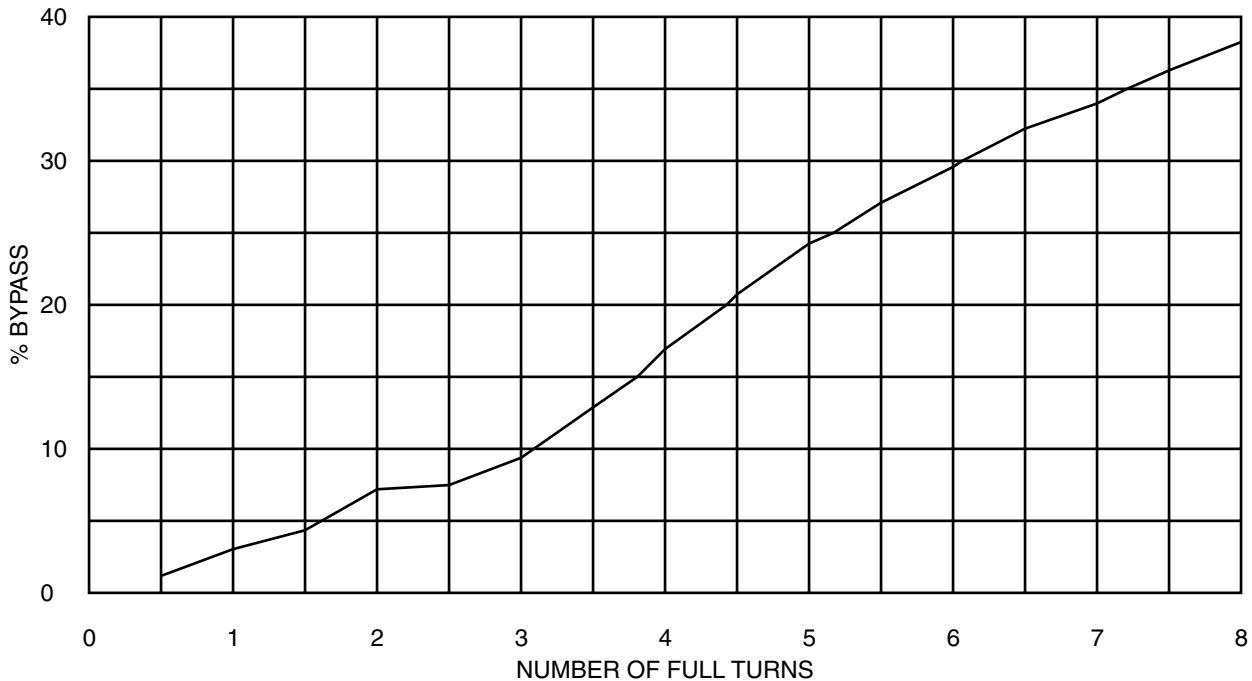

**NOTE:** To increase the water bypass turn the needle valve counterclockwise, to decrease the water bypass turn the needle valve clockwise. An adjustment of the needle valve will require a timer adjustment for volume. To determine how many turns must be performed to achieve the desired volume, use the chart below.

**NOTE:** The factory bypass is set at 20%

8. Repeat step 7 until the proper water volume is achieved.
9. Repeat steps 5 through 8 for the remaining brew station.
10. The brewer is now ready for use in accordance with the coffee brewing instructions.

## ADJUSTING BREW VOLUMES

**CAUTION** - Disconnect the power source from the brewer prior to the removal of any panel for the replacement or adjustment of any component.

**NOTE:** Prior to setting or modifying batch sizes, check that the brewer is connected to water supply, the tank is properly filled, and a funnel and server are in place.

1. **Modifying batch sizes.** To modify a batch volume, first check that the SET/LOCK switch is in the "SET" position on the circuit board.

**To increase a batch size.** Press and hold the START or BREW switch until three clicks are heard. Release the switch (Failure to release the switch within two seconds after the third click causes the volume setting to be aborted and previous volume setting will remain in memory) and press it again one or more times. Each time the switch is pressed, two seconds are added to the brew time period. Allow the brew cycle to finish in order to verify that the desired volume has been achieved.

**To decrease a batch size.** Press and release the START or BREW switch once for every two-second interval

## INITIAL SET-UP (cont.)

to be removed from the total brew time period; then immediately press and hold down the START or BREW switch until three clicks are heard. Release the switch. (Failure to release the switch within two seconds after the third click causes the volume setting to be aborted and previous volume setting will remain in memory). Allow the brew cycle to finish in order to verify that the desired volume has been achieved.

2. **Setting batch sizes.** To set a batch volume, first check that the SET/LOCK switch is in the "SET" position on the circuit board. Press and hold the START or BREW switch until three distinct clicks are heard, and then release the switch. (Failure to release the switch within two seconds after the third click causes the volume setting to be aborted and previous volume setting will remain in memory). View the level of the liquid being dispensed. When the desired level is reached, turn the ON/OFF switch to "OFF" (lower). The brewer remembers this volume and will continue to brew batches of this size until the volume setting procedure is repeated.

**NOTE:** When brewing coffee, batch volumes will decrease due to absorption by the coffee grounds.

3. **Setting programming disable feature.** If it becomes necessary to prevent anyone from changing brew times once programmed, you can set the SET/LOCK switch to the "LOCK" position. This will prevent any programming to be done until switch is once again placed in the "SET" position.

**NOTE:** If the clicks can not be heard, lightly grip the incoming water line to feel when the valve cycles on and off.

## OPERATING CONTROLS

### BREW SELECTOR SWITCH (Triple - set timer models only)

Placing the switch in the ½ Gal, 1 Gal, or 1½ Gal position selects the amount of coffee to be brewed in subsequent brew cycles. Repositioning this switch after a brew cycle has been initiated does not change the brew batch in progress.

### ON/OFF SWITCH

Placing the switch in the unlighted lower position cuts power to the brew station warmer and stops brewing. Stopping a brew cycle after it has been started will not stop the flow of water from the funnel. Placing the switch in the lighted upper position supplies power to the brew station warmer and enables the brew circuit.

### START SWITCH

Momentarily pressing and releasing this switch starts a brew cycle when the On/Off switch is in the lighted upper position.

### GRINDER SELECTOR SWITCH

Pressing the right or left side of the switch selects the corresponding brew station.

**NOTE** – The On/Off switch must be in the lighted upper position to initiate and complete a brew cycle.

## COFFEE BREWING

1. Select the desired batch size.
2. Insert a BUNN filter into the funnel.
3. Pour the proper amount of fresh ground coffee into filter and level the bed of grounds by gently shaking.
4. Slide the funnel into the funnel rails.
5. Place an empty server under the funnel.
6. Place the On/Off switch in the lighted upper position. Momentarily press and release the start switch.
7. When brewing is completed, simply discard the grounds and filter.

## CLEANING

1. The use of a damp cloth rinsed in any mild, non-abrasive, liquid detergent is recommended for cleaning all surfaces on Bunn-O-Matic equipment.
2. Check and clean the sprayhead. The sprayhead holes must always remain open.

**NOTE** – In hard water areas, this may need to be done daily. It will help prevent liming problems in the brewer and takes less than a minute.