

ICB Twin, 120/240V SST Tall

Height: 35.0" Width: 20.2" Depth: 22.3"
(88.9cm) (51.3cm) (56.6cm)



- Sleek modernized design language, with rounded angles on the corners and trunk
- Brews into 3.8 and 5.7L (1 to 1.5 gallon) Thermofresh Servers (with base)
- Digital readout displays in English, Spanish, or French ---for easier programming and control--- and can show either 'Standard' or Metric measurements. Digital readout also shows machine status, and targeted advertising messages can be programmed for display.
- Large 5.6 gallon (21.2L) tank provides back-to-back brewing capacity
- BUNN Infusion Series technology allows for multiple recipes from one footprint --- with three brew buttons and two batch sizes
- Energy-saver mode reduces tank temperature during idle periods
- The exclusive Peak Extraction® Sprayhead provides improved uniformity of extraction and greater resistance to limescale buildup.
- Electronic funnel lock prevents removal of each brew funnel until drip- through is complete
- USB programming capable
- Brew counter keeps track of how many batches are brewed
- Pre-infusion and pulse brew for maximum flavor extraction. Cold brew lockout & digital temperature control further ensure top-notch brewing.
- Hot water faucet (supplied for custom installation)

Server(s) sold separately

Agency:



Specifications

Product #: 53200.0101

Water Access: Plumbed

Interface: Wireless

Funnel: Black Plastic

Additional Features

Electrical & Capacity

| Volts* | Amps | Watts | Cord Attached | Plug Type | 8oz cups/hr 236ml cups/hr | Input H ₂ O Temp. | Phase | # Wires plus Ground | Hertz |
|---------|------|-------|---------------|-----------|------------------------------|------------------------------|-------|---------------------|-------|
| 120/240 | 25 | 6000 | Yes/ | - | 280 | 60°F (15.5°C) | 1 | 3 | 60 |

*When a BUNN is machine rated 120/208-240V, 120/208V or 120/240V, the higher voltage is the supply voltage needed to power the machine. The 120V is there to supply power to some components rated 120V in the machine, but it is not the supply voltage and would not power the machine if the machine is marked with the before mentioned ratings.

Plumbing Requirements

| PSI | kPa | Fitting Supplied | Water Flow Required (GPM) |
|-------|---------|-------------------------|---------------------------|
| 20-90 | 138-621 | 3/8" Male Flare Fitting | 1.00 |

CAD Drawings

| 2D | Revit | KLC |
|----|-------|-----|
| ● | ● | ● |

WARNING: This product can expose you to chemicals including Bisphenol A (BPA), which is known to the State of California to cause birth defects or other reproductive harm. For more information go to www.P65Warnings.ca.gov



BUNN® reserves the right to change specifications and product design without notice. Such revisions do not entitle the buyer to corresponding changes, improvements, additions or replacements for previously purchased equipment. For most current specifications and other info visit bunn.com.

Last Updated:
03/25/2026

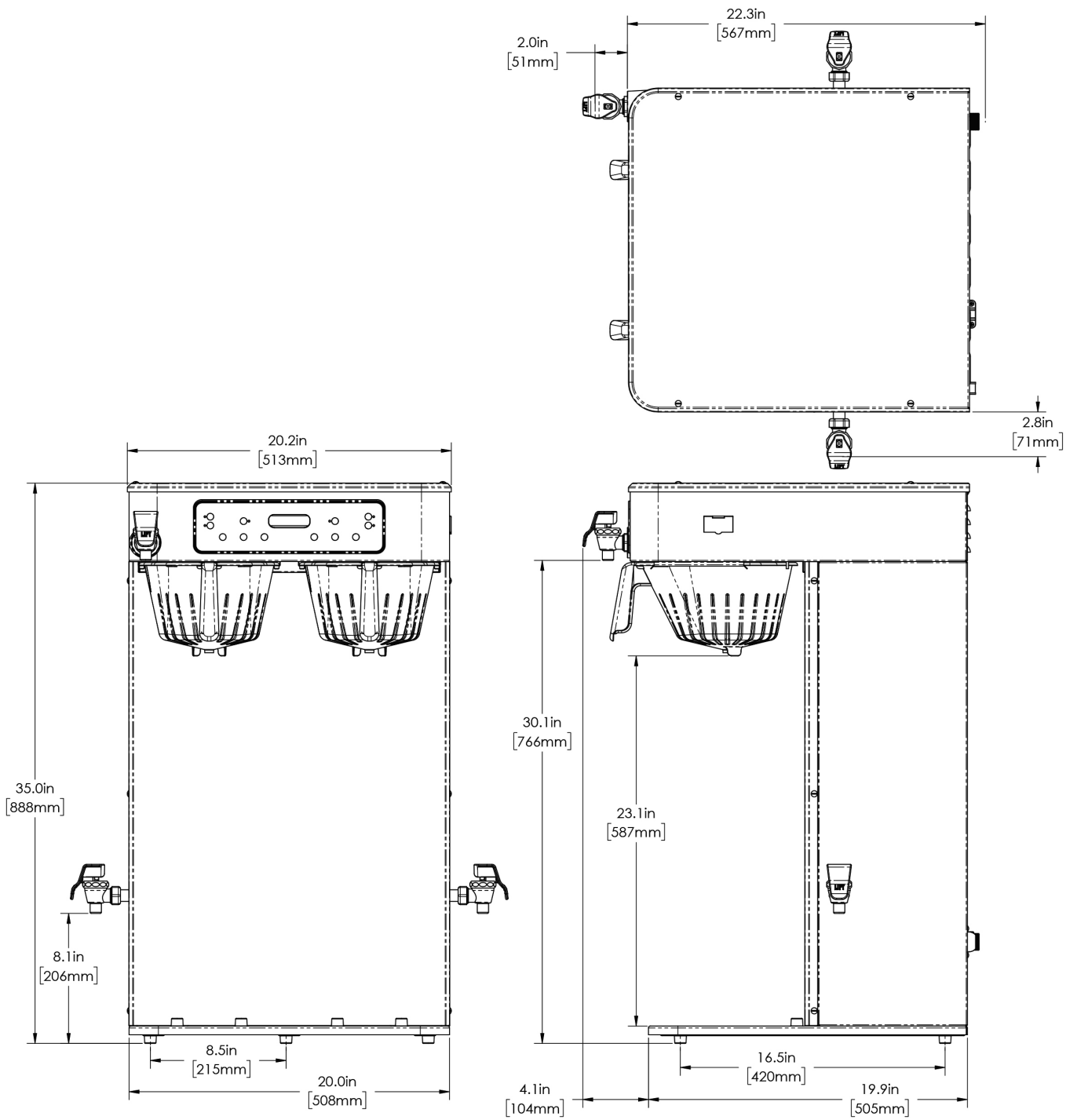



| | Unit | | | Shipping | | | | |
|---------|----------|----------|----------|----------|----------|----------|------------|------------|
| | Height | Width | Depth | Height | Width | Depth | Weight | Volume |
| English | 35.0 in. | 20.2 in. | 22.3 in. | 38.3 in. | 23.8 in. | 28.4 in. | 78.460 lbs | 14.917 ft³ |
| Metric | 88.9 cm | 51.3 cm | 56.6 cm | 97.2 cm | 60.3 cm | 72.1 cm | 35.589 kgs | 0.422 m³ |





BUNN® reserves the right to change specifications and product design without notice. Such revisions do not entitle the buyer to corresponding changes, improvements, additions or replacements for previously purchased equipment. For most current specifications and other info visit bunn.com.

Last Updated:
03/25/2026

Related Products & Accessories: ICB Twin, 120/240V SST Tall(53200.0101)

| | | | | |
|---|---|--|--|--|
|  <p>FILTERS, GOURMET 500 500/1 50/CL</p> <p>Product #: 20138.1000</p> |  <p>WATER FILTER, EQHP-10L</p> <p>Product #: 39000.0001³</p> |  <p>WATER FILTER, EQHP-10</p> <p>Product #: 39000.0004³</p> |  <p>FUNNEL ASSY, SMART COFFEE BLK-CLEARED</p> <p>Product #: 53463.0021</p> |  <p>FUNNEL ASSY, SMART COFFEE BLK-CLEARED</p> <p>Product #: 53463.0038²</p> |
|---|---|--|--|--|

| | | | | |
|---|--|--|---|--|
|  <p>SYSTEM, WQ-55(2)5L</p> <p>Product #: 56000.0001¹</p> |  <p>SYSTEM, WQ-55(2)5</p> <p>Product #: 56000.0004¹</p> |  <p>SYSTEM, WEQ-10(1.5)5L</p> <p>Product #: 56000.0024¹</p> |  <p>SYSTEM, WEQ-10(1.5)5</p> <p>Product #: 56000.0027¹</p> |  <p>CARTRIDGE, WQ-55(2)5L</p> <p>Product #: 56000.0101¹</p> |
|---|--|--|---|--|

| | | |
|---|---|--|
|  <p>CARTRIDGE, WQ-55(2)5</p> <p>Product #: 56000.0104¹</p> |  <p>CARTRIDGE, WEQ-10(1.5)5L</p> <p>Product #: 56000.0121¹</p> |  <p>CARTRIDGE, WEQ-10(1.5)5</p> <p>Product #: 56000.0122¹</p> |
|---|---|--|

¹NSF Certified ²NSF Certified with spec sheet model listed ³NSF Certified under Solventum Purification ⁴NSF Certified under Vivreau Ltd ⁵NSF Certified under Zojirushi ⁶NSF Certified under Qins Inc ⁷NSF COMPONENT Certified



BUNN® reserves the right to change specifications and product design without notice. Such revisions do not entitle the buyer to corresponding changes, improvements, additions or replacements for previously purchased equipment. For most current specifications and other info visit bunn.com.

Last Updated:
03/25/2026

Serving & Holding Options: ICB Twin, 120/240V SST Tall(53200.0101)



TF SERVER, 1G DSG
GEN3

Product #: 42700.0200¹



TF SERVER, 1.5G DSG
GEN3

Product #: 42750.0200¹



TF SERVER, 1G MECH
GEN3

Product #: 44000.0200¹



TF SERVER, 1.5G MECH
GEN3

Product #: 44050.0200¹

STAND ASSY, TF
SERVER

Product #: 54473.0000



STAND ASSY KIT, TF
SERVER

Product #: 54473.1000

¹NSF Certified ²NSF Certified with spec sheet model listed ³NSF Certified under Solventum Purification ⁴NSF Certified under Vivreau Ltd ⁵NSF Certified under Zojirushi ⁶NSF Certified under Qins Inc ⁷NSF COMPONENT Certified



BUNN® reserves the right to change specifications and product design without notice. Such revisions do not entitle the buyer to corresponding changes, improvements, additions or replacements for previously purchased equipment. For most current specifications and other info visit bunn.com.

Last Updated:
03/25/2026