

BW4 CTM-P-RL W/ 1yr Service

Height: 25.4" Width: 27.2" Depth: 23.6"
(64.5cm) (69.1cm) (59.9cm)



- High feet to clean under and behind the machine
- 25 gram metal brew chamber supports triple shot beverages
- Capable of dairy and non-dairy milk options with a 2 milk system. Risk of cross-contamination between alternative and dairy milks
- With chocolate powder option (4.4 lb), offer rich mochas and hot chocolate
- Dual boiler system designed for 500 cup/day performance
- Rich, creamy espresso drinks made with fresh, foamed milk at the touch of a button
- Two 3.7 lb bean hoppers with two grinders for your choice of espresso beans
- Large, integrated refrigerator holding up to 10L of milk
- Easy-to-use 10" touch screen with beautiful graphics to guide the operator
- Customizable user interface to select your favorite beverages
- Simple, screen-prompted automatic cleaning process with reminder and lockout
- Adjustable height product dispense spout
- Built-in troubleshooting menus
- Installation and preventative maintenance included

Caution: Milk Allergens

Agency:



Specifications

Product #: 59000.0006

Steps: 1 Step

Water Access: Plumbed

Finish: Stainless

Additional Features

Electrical & Capacity

Volts*	Amps	Watts	Cord Attached	Plug Type	8oz cups/hr 236ml cups/hr	Input H ₂ O Temp.	Phase	# Wires plus Ground	Hertz
208	27.0	5700	-	-	-	60°F (15.5°C)	1	2	60

*When a BUNN is machine rated 120/208-240V, 120/208V or 120/240V, the higher voltage is the supply voltage needed to power the machine. The 120V is there to supply power to some components rated 120V in the machine, but it is not the supply voltage and would not power the machine if the machine is marked with the before mentioned ratings.

Plumbing Requirements

PSI	kPa	Fitting Supplied	Water Flow Required (GPM)
30-60	207-414	3/8" Inlet	-

CAD Drawings

2D	Revit	KLC

WARNING:



BUNN® reserves the right to change specifications and product design without notice. Such revisions do not entitle the buyer to corresponding changes, improvements, additions or replacements for previously purchased equipment. For most current specifications and other info visit bunn.com.

Last Updated:
04/16/2026

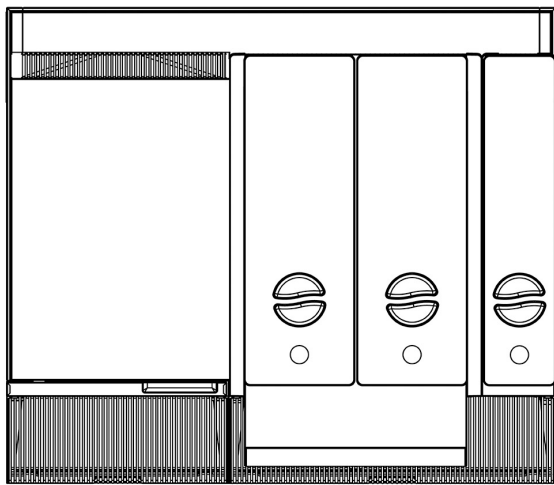
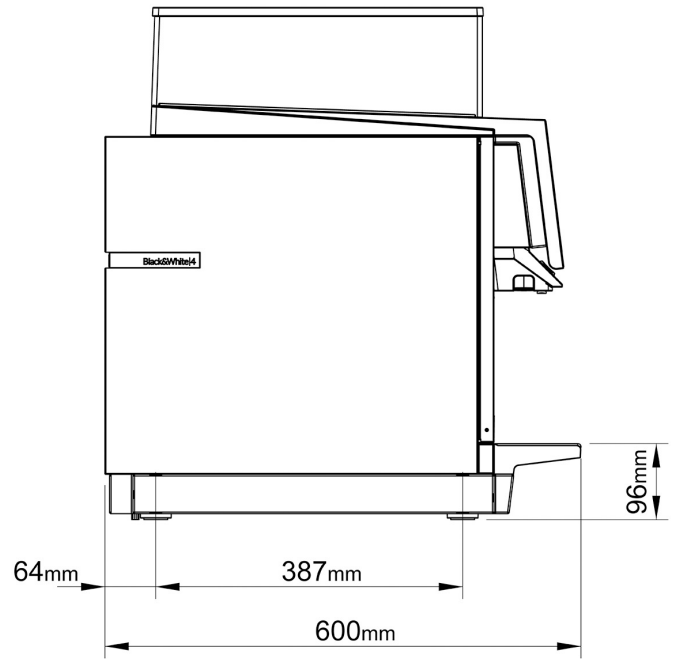
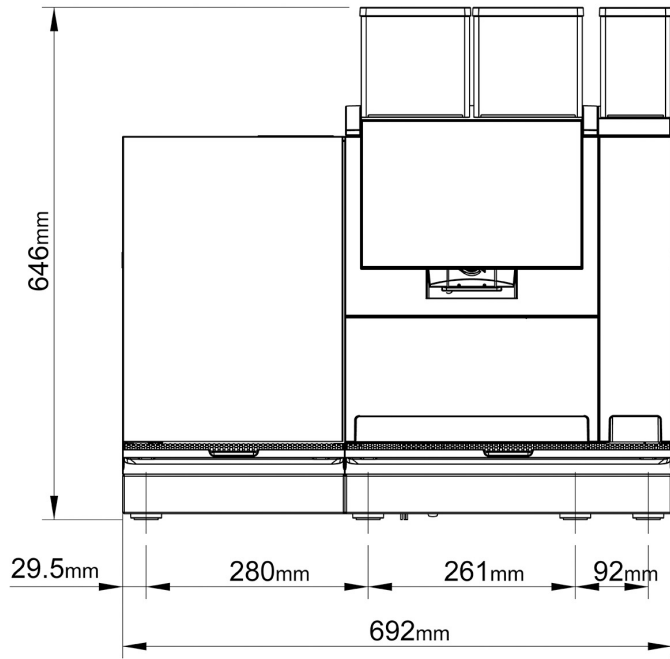





	Unit			Shipping				
	Height	Width	Depth	Height	Width	Depth	Weight	Volume
English	25.4 in.	27.2 in.	23.6 in.	25.4 in.	27.2 in.	23.6 in.	109.000 lbs	9.436 ft ³
Metric	64.5 cm	69.1 cm	59.9 cm	64.5 cm	69.1 cm	59.9 cm	49.442 kgs	0.267 m ³



BUNN® reserves the right to change specifications and product design without notice. Such revisions do not entitle the buyer to corresponding changes, improvements, additions or replacements for previously purchased equipment. For most current specifications and other info visit bunn.com.

Last Updated:
04/16/2026

Related Products & Accessories: BW4 CTM-P-RL W/ 1yr Service(59000.0006)

 <p>TABLETS, 62 MILK SYSTEM CLEANING -1 JAR</p> <p>Product #: 43500.1446</p>	 <p>KIT, C300 WATER CONDITIONER ASSY</p> <p>Product #: 45961.0000 Mfr#:Purity C300 Quell ST</p>	<p>NO IMAGE AVAILABLE</p> <p>KIT, WATER FILTER CARTRIDGE C300</p> <p>Product #: 45961.1001⁴</p>	 <p>BRUSH, ANGLED 12 INCH</p> <p>Product #: 47745.0000</p>	 <p>MILK SYS CLEANING TABLETS (12/CS)</p> <p>Product #: 49140.0002</p>
<p>CLEANING KEY MILKWAY ASSY</p> <p>Product #: 55300.1004</p>	<p>CLEANINGKEY COFFEE ASSY</p> <p>Product #: 55300.1162</p>	<p>MILKCONTAINER RS ASSY</p> <p>Product #: 55300.1219</p>	<p>BOX, THERMO COFFEE TABS 12 JARS</p> <p>Product #: 55300.1521</p>	 <p>JAR THERMO COFFEE TABS</p> <p>Product #: 55300.1522</p>

¹NSF Certified ²NSF Certified with spec sheet model listed ³NSF Certified under Solventum Purification ⁴NSF Certified under Vivreau Ltd ⁵NSF Certified under Zojirushi ⁶NSF Certified under Qins Inc ⁷NSF COMPONENT Certified



BUNN® reserves the right to change specifications and product design without notice. Such revisions do not entitle the buyer to corresponding changes, improvements, additions or replacements for previously purchased equipment. For most current specifications and other info visit bunn.com.

Last Updated:
04/16/2026

Serving & Holding Options: BW4 CTM-P-RL W/ 1yr Service(59000.0006)

Serving and Holding selections are currently unavailable. Please contact your sales representative to find out more information.

¹NSF Certified ²NSF Certified with spec sheet model listed ³NSF Certified under Solventum Purification ⁴NSF Certified under Vivreau Ltd ⁵NSF Certified under Zojirushi ⁶NSF Certified under Qins Inc ⁷NSF COMPONENT Certified



BUNN® reserves the right to change specifications and product design without notice. Such revisions do not entitle the buyer to corresponding changes, improvements, additions or replacements for previously purchased equipment. For most current specifications and other info visit bunn.com.

Last Updated:
04/16/2026