

# All NITRON®, 220-240V ME w/black door

Height: 34.0" Width: 10.0" Depth: 28.4"  
(86.4cm) (25.4cm) (72.1cm)



- Serve different coffees or teas, one Nitro and one Still, using two 3.78 liter ball-valve concentrate BIBs or BUNN refillable containers
- Patented High Intensity® mixing chamber assures a perfectly blended finished beverage, from cup to cup
- Chrome-plated brass tap handles and nitro stout nozzles provide the quality-oriented craft experience of serving a premium beverage on tap
- Automatic water bath fill maintains water bath level for optimal cold beverage capacity
- Sleek, all-black door complements any commercial setting
- At a rate of one 473 ml drink per minute, can dispense 60 drinks before exceeding 5°C (@23.9°C incoming water)
- Refrigerated product cabinet protects flavor integrity and product life
- Large dispense area accommodates taller cups and carafes up to 22.3 cm

Agency:

KUCAS ECAS

## Specifications

**Product #:** 51600.0049

**Dispense:** Pull & Hold

**Water Access:** Plumbed

**Legs:** 4" Black Legs

**Finish:** Black

**Door:** Side Hinge

## Additional Features

## Electrical & Capacity

Volts*	Amps	Watts	Cord Attached	Plug Type	8oz cups/hr 236ml cups/hr	Input H <sup>2</sup> O Temp.	Phase	# Wires plus Ground	Hertz
220-240	2.25-2.75	410-520	Yes	UK 13A	-	60°F (15.5°C)	1	2	50-60

\*When a BUNN is machine rated 120/208-240V, 120/208V or 120/240V, the higher voltage is the supply voltage needed to power the machine. The 120V is there to supply power to some components rated 120V in the machine, but it is not the supply voltage and would not power the machine if the machine is marked with the before mentioned ratings.

## Plumbing Requirements

PSI	kPa	Fitting Supplied	Water Flow Required (GPM)
30-90	207-621	3/8" Male Flare Fitting	0.94

## CAD Drawings

2D	Revit	KLC
●		

**WARNING:**



BUNN® reserves the right to change specifications and product design without notice. Such revisions do not entitle the buyer to corresponding changes, improvements, additions or replacements for previously purchased equipment. For most current specifications and other info visit [bunn.com](http://bunn.com).

Last Updated:  
09/18/2025

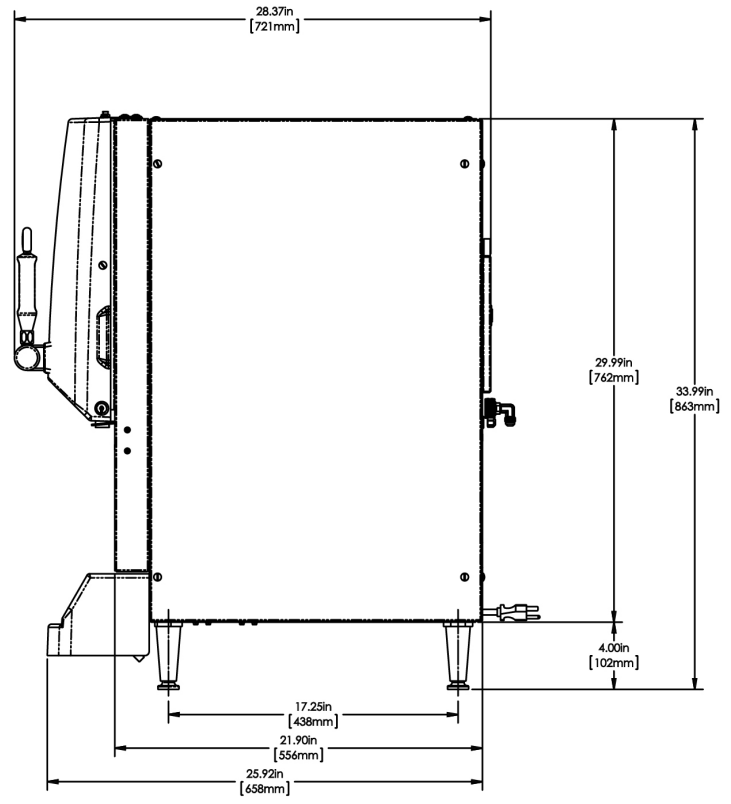
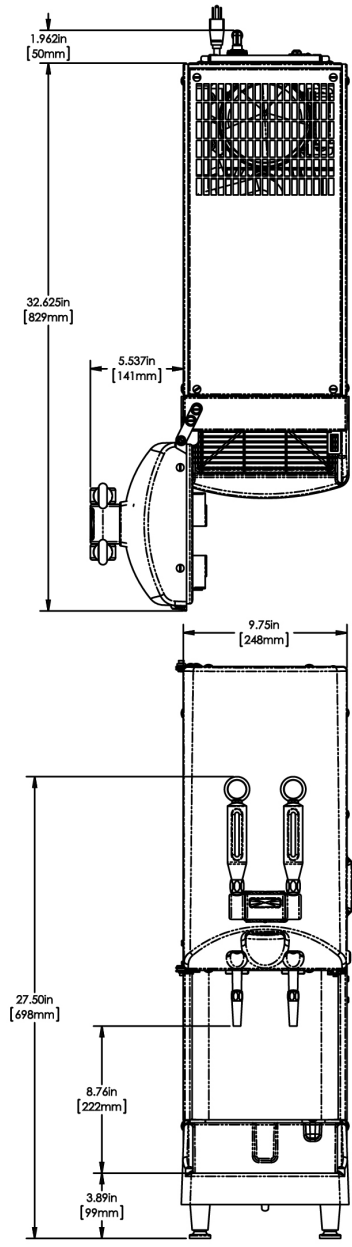





Unit			Shipping					
	Height	Width	Depth	Height	Width	Depth	Weight	Volume
English	34.0 in.	10.0 in.	28.4 in.	43.7 in.	22.8 in.	30.5 in.	135.700 lbs	17.586 ft <sup>3</sup>
Metric	86.4 cm	25.4 cm	72.1 cm	111.0 cm	57.9 cm	77.5 cm	61.554 kgs	0.498 m <sup>3</sup>



BUNN® reserves the right to change specifications and product design without notice. Such revisions do not entitle the buyer to corresponding changes, improvements, additions or replacements for previously purchased equipment. For most current specifications and other info visit [bunn.com](http://bunn.com).

Last Updated:  
09/18/2025

# Related Products & Accessories: All NITRON®, 220-240V ME w/black door(51600.0049)

 <p>SANITIZER,KAY-5 (BOX-200 PKTS)</p> <hr/> <p>Product #: 24634.0000</p>	 <p>SANITIZER,KAY-5 (BOX-50 PKTS)</p> <hr/> <p>Product #: 24634.0001</p>	 <p>CONTAINER ASSY, REFILLABLE</p> <hr/> <p>Product #: 39302.0000<sup>2</sup></p>	 <p>KIT, TST 2 VALVE NITRON</p> <hr/> <p>Product #: 45536.1004</p>	 <p>KIT, PRIMARY N2 REGULATOR</p> <hr/> <p>Product #: 54060.0000<sup>2</sup></p>
--	---	--	---	---

 <p>NITRON GAS MODULE, 120V 60HZ</p> <hr/> <p>Product #: 55660.0005<sup>1</sup></p>	<p>KIT, FILTERS NGM</p> <hr/> <p>Product #: 56333.0000</p>
--	--

<sup>1</sup>NSF Certified <sup>2</sup>NSF Certified with spec sheet model listed <sup>3</sup>NSF Certified under Solventum Purification <sup>4</sup>NSF Certified under Mavea LLC <sup>5</sup>NSF Certified under Zojirushi <sup>6</sup>NSF Certified under Qins Inc <sup>7</sup>NSF COMPONENT Certified



BUNN® reserves the right to change specifications and product design without notice. Such revisions do not entitle the buyer to corresponding changes, improvements, additions or replacements for previously purchased equipment. For most current specifications and other info visit [bunn.com](http://bunn.com).

Last Updated:  
09/18/2025

# Serving & Holding Options: All NITRON®, 220-240V ME w/black door(51600.0049)

\*Serving and Holding selections are currently unavailable. Please contact your sales representative to find out more information.\*

---

<sup>1</sup>NSF Certified <sup>2</sup>NSF Certified with spec sheet model listed <sup>3</sup>NSF Certified under Solventum Purification <sup>4</sup>NSF Certified under Mavea LLC <sup>5</sup>NSF Certified under Zojirushi <sup>6</sup>NSF Certified under Qins Inc <sup>7</sup>NSF COMPONENT Certified



BUNN® reserves the right to change specifications and product design without notice. Such revisions do not entitle the buyer to corresponding changes, improvements, additions or replacements for previously purchased equipment. For most current specifications and other info visit [bunn.com](http://bunn.com).

Last Updated:  
09/18/2025