

# WAVE15-APS, PF

Height: 17.4" Width: 9.7" Depth: 17.9"  
(44.2cm) (24.6cm) (45.5cm)



- BrewMETER® allows automatic programming of pulse routine
- Adjustable legs to accommodate up to 3.0L lever action and 2.5L push button BUNN airpots and thermal servers
- Brew into 1.9L thermal carafe using the slide-out booster tray
- Four-digit LED read-out for simple programming
- Utilize the same LED read-out for brewer status (Ready, Heating, Brewing)
- SmartWAVE technology increases turbulence in the brew funnel
- Standard Version
- Energy-saver mode reduces tank temperature during idle periods
- Ensures coffee brew quality with cold brew lock out capability
- SplashGard® funnel deflects hot liquids away from the hand
- Servers not included unless otherwise noted

Server(s) sold separately

Agency:



## Specifications

**Product #:** 39900.0005

**Faucet:** Lower

**Water Access:** Plumbed

**Finish:** Stainless

**Funnel:** Black Plastic

## Additional Features

BrewMETER

## Electrical & Capacity

Volts*	Amps	Watts	Cord Attached	Plug Type	8oz cups/hr 236ml cups/hr	Input H <sub>2</sub> O Temp.	Phase	# Wires plus Ground	Hertz
120	11.3	1350	Yes	NEMA 5-15P	62	60°F (15.5°C)	1	2	60

\*When a BUNN is machine rated 120/208-240V, 120/208V or 120/240V, the higher voltage is the supply voltage needed to power the machine. The 120V is there to supply power to some components rated 120V in the machine, but it is not the supply voltage and would not power the machine if the machine is marked with the before mentioned ratings.

## Plumbing Requirements

PSI	kPa	Fitting Supplied	Water Flow Required (GPM)
20-90	138-621	1/4" Male Flare Fitting	-

## CAD Drawings

2D	Revit	KLC
●		

**WARNING:**



BUNN® reserves the right to change specifications and product design without notice. Such revisions do not entitle the buyer to corresponding changes, improvements, additions or replacements for previously purchased equipment. For most current specifications and other info visit [bunn.com](http://bunn.com).

Last Updated:  
01/16/2026

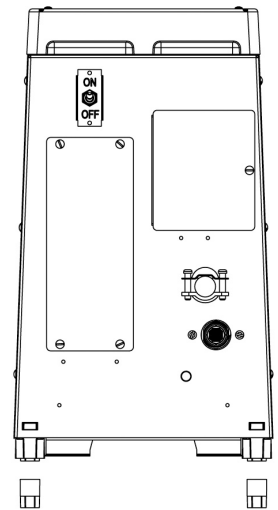
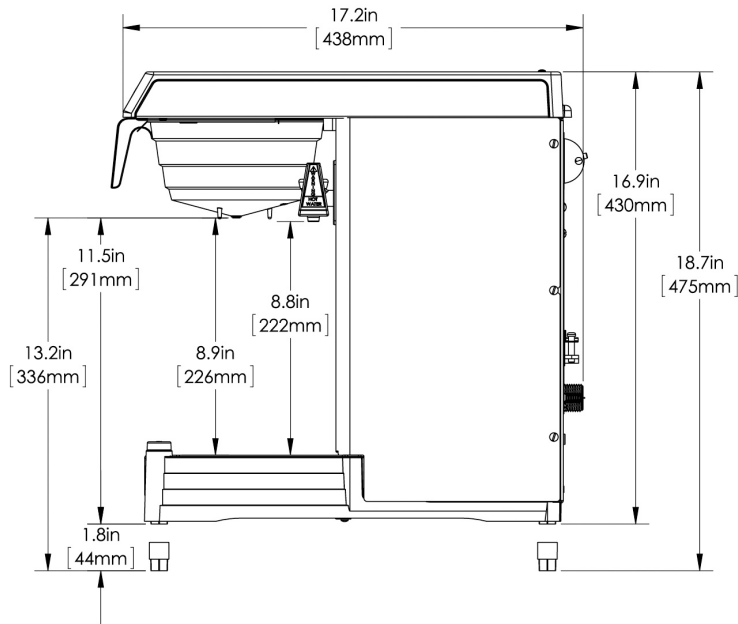
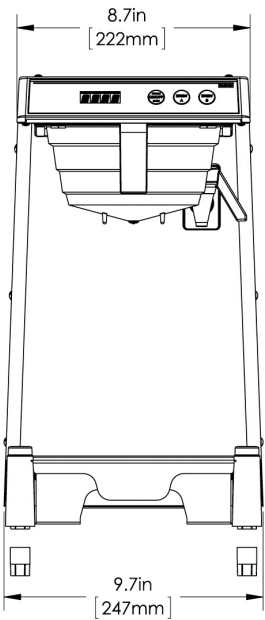
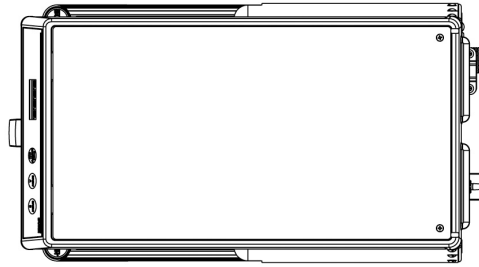





	Unit			Shipping				
	Height	Width	Depth	Height	Width	Depth	Weight	Volume
English	17.4 in.	9.7 in.	17.9 in.	19.5 in.	12.4 in.	19.5 in.	24.350 lbs	2.723 ft <sup>3</sup>
Metric	44.2 cm	24.6 cm	45.5 cm	49.5 cm	31.4 cm	49.5 cm	11.045 kgs	0.077 m <sup>3</sup>



BUNN® reserves the right to change specifications and product design without notice. Such revisions do not entitle the buyer to corresponding changes, improvements, additions or replacements for previously purchased equipment. For most current specifications and other info visit [bunn.com](http://bunn.com).

Last Updated:  
01/16/2026

# Related Products & Accessories: WAVE15-APS, PF(39900.0005)

 <p>FUNNEL W/DECAL,PPK NAR BLK(SM)</p> <p>Product #: 02774.0011<sup>2</sup></p>	 <p>FUNNEL W/DECAL,PPK NAR BLK(LG)</p> <p>Product #: 04274.0012<sup>2</sup></p>	 <p>FILTERS,REGULAR1M 500/2 50/CL</p> <p>Product #: 20115.0000</p>	 <p>FUNNEL ASSY, SST-BLK HDL(7.12)</p> <p>Product #: 20216.0000<sup>2</sup></p>	 <p>FUNNEL W/DECALS, BLACK PLASTIC</p> <p>Product #: 20583.0003<sup>2</sup></p>
 <p>FUNNEL ASSY, SST-PP BLK HDL</p> <p>Product #: 29151.0000<sup>2</sup></p>	 <p>FUNNEL ASSY,SST-PP ORANGE HDL</p> <p>Product #: 29151.0001<sup>2</sup></p>	 <p>WATER FILTER SYSTEM,EQ-17-TL</p> <p>Product #: 30200.1000<sup>3</sup></p>	 <p>WATER FILTER,IN LINE ED-17-TL</p> <p>Product #: 30201.1001<sup>3</sup></p>	 <p>FUNNEL AY,W/DECAL GRT "C"7.12</p> <p>Product #: 34559.0000<sup>2</sup></p>
 <p>SYSTEM, WEQ-10(1.5)5L</p> <p>Product #: 56000.0024<sup>1</sup></p>	 <p>CARTRIDGE, WEQ-10 (1.5)5L</p> <p>Product #: 56000.0121<sup>1</sup></p>	 <p>CARTRIDGE, WEQ-10.3 (1.67)5L</p> <p>Product #: 56000.0137<sup>1</sup></p>		

<sup>1</sup>NSF Certified <sup>2</sup>NSF Certified with spec sheet model listed <sup>3</sup>NSF Certified under Solventum Purification <sup>4</sup>NSF Certified under Mavea LLC <sup>5</sup>NSF Certified under Zojirushi <sup>6</sup>NSF Certified under Qins Inc <sup>7</sup>NSF COMPONENT Certified



BUNN® reserves the right to change specifications and product design without notice. Such revisions do not entitle the buyer to corresponding changes, improvements, additions or replacements for previously purchased equipment. For most current specifications and other info visit [bunn.com](http://bunn.com).

Last Updated:  
01/16/2026

# Serving & Holding Options: WAVE15-APS, PF(39900.0005)

 <p><b>TSR-1,THERMAL SRVR RACK-1 POSN</b></p> <p>Product #: 18008.6001</p>	 <p><b>AIRPOT, 2.5L SST LA SINGLE PK</b></p> <p>Product #: 32125.0000<sup>6</sup> Mfr#:SVAP-2500F-N</p>	 <p><b>AIRPOT, 2.5L SST LA 6/ CASE</b></p> <p>Product #: 32125.0100<sup>6</sup> Mfr#:SVAP-2500F-N</p>	 <p><b>AIRPOT, 3.0L SST LA SINGLE PK</b></p> <p>Product #: 32130.0000<sup>6</sup> Mfr#:SVAP-3000F-N</p>	 <p><b>AIRPOT, 3.0L SST LA 6/ CASE</b></p> <p>Product #: 32130.0100<sup>6</sup> Mfr#:SVAP-3000F-N</p>
---	--	--	--	--

 <p><b>THERMAL CARAFE, BLK 1.83 L 1PK</b></p> <p>Product #: 36029.0001<sup>5</sup> Mfr#:SH-DE19A</p>	 <p><b>THERMAL CARAFE,ORN 1.9L 12PK</b></p> <p>Product #: 36252.0000<sup>5</sup> Mfr#:SH-DE19A</p>	 <p><b>THERMAL CARAFE,ORN 1.9L 1PK</b></p> <p>Product #: 36252.0001<sup>5</sup> Mfr#:SH-DE19A</p>	 <p><b>PITCHER,SST 1.9L TALL- SNGL PK</b></p> <p>Product #: 39430.0000<sup>6</sup> Mfr#:SVP-1901DSG</p>	 <p><b>PITCHER,SST 1.9L TALL-6/CASE</b></p> <p>Product #: 39430.0100<sup>6</sup> Mfr#:SVP-1901DSG</p>
--	---	--	--	--

 <p><b>CARAFE,SST 1.9L SHRT BLK 1</b></p> <p>Product #: 40163.0000<sup>6</sup></p>	<p>NO IMAGE AVAILABLE</p> <p><b>THERMAL SRVR, 2.5L 6/ CS NO BASE GL LINR</b></p> <p>Product #: 45882.0001<sup>1</sup></p>
--	---

<sup>1</sup>NSF Certified <sup>2</sup>NSF Certified with spec sheet model listed <sup>3</sup>NSF Certified under Solventum Purification <sup>4</sup>NSF Certified under Mavea LLC <sup>5</sup>NSF Certified under Zojirushi <sup>6</sup>NSF Certified under Qins Inc <sup>7</sup>NSF COMPONENT Certified



BUNN® reserves the right to change specifications and product design without notice. Such revisions do not entitle the buyer to corresponding changes, improvements, additions or replacements for previously purchased equipment. For most current specifications and other info visit [bunn.com](http://bunn.com).

Last Updated:  
01/16/2026