

DUAL TF DBC® SST 120/208V w/Fnl Locks

Height: 35.7" Width: 21.8" Depth: 23.8"
(90.7cm) (55.4cm) (60.5cm)



- Brews 16.3 to 18.9gal (61.7 to 71.5L) of perfect coffee per hour
- Coffee extraction controlled with pre-infusion and pulse brew, digital temperature control, and large sprayhead; coffee strength controlled with variable by-pass.
- Create coffee recipe cards with custom recipes, ad cards with messages that display on the brewer LCD, and dedicated funnels for special coffees with the BrewWISE Recipe Writer using your PC (Windows® compatible).
- Easy pulse interface allows automatic programming of pulse routine
- Preventive maintenance kit: 39641.0000
- Stores individual coffee recipes so operator can easily brew many varieties
- ThermoFresh® servers are vacuum insulated to keep coffee hot for hours.
- SplashGard® funnels deflect hot liquids away from the hand
- Energy saver mode reduces tank temperature during idle periods
- Operate any combination of BrewWISE equipment error-free with wireless brewer-grinder interface through Smart Funnel with SplashGard®
- Funnel locks help improve safety
- Servers not included unless otherwise noted

Server(s) sold separately

Agency:



Specifications

Product #: 34600.0006

Funnel: Smart Funnel

Water Access: Plumbed

Faucet: Lower

Interface: Wireless

Finish: Stainless

Additional Features

BrewWISE

Electrical & Capacity

| Volts* | Amps | Watts | Cord Attached | Plug Type | 8oz cups/hr 236ml cups/hr | Input H ₂ O Temp. | Phase | # Wires plus Ground | Hertz |
|---------|------|-------|---------------|-----------|------------------------------|------------------------------|-------|---------------------|-------|
| 120/208 | 27.4 | 5700 | No | - | 266 | 60°F (15.5°C) | 1 | 3 | 60 |

*When a BUNN is machine rated 120/208-240V, 120/208V or 120/240V, the higher voltage is the supply voltage needed to power the machine. The 120V is there to supply power to some components rated 120V in the machine, but it is not the supply voltage and would not power the machine if the machine is marked with the before mentioned ratings.

Plumbing Requirements

| PSI | kPa | Fitting Supplied | Water Flow Required (GPM) |
|-------|---------|-------------------------|---------------------------|
| 20-90 | 138-621 | 3/8" Male Flare Fitting | - |

CAD Drawings

| 2D | Revit | KLC |
|----|-------|-----|
| ● | | |

WARNING:



BUNN® reserves the right to change specifications and product design without notice. Such revisions do not entitle the buyer to corresponding changes, improvements, additions or replacements for previously purchased equipment. For most current specifications and other info visit bunn.com.

Last Updated:
02/05/2026

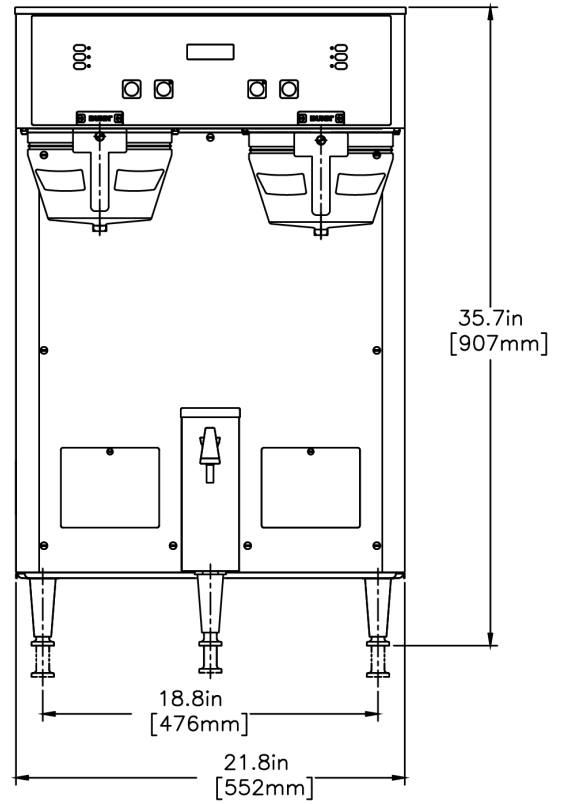
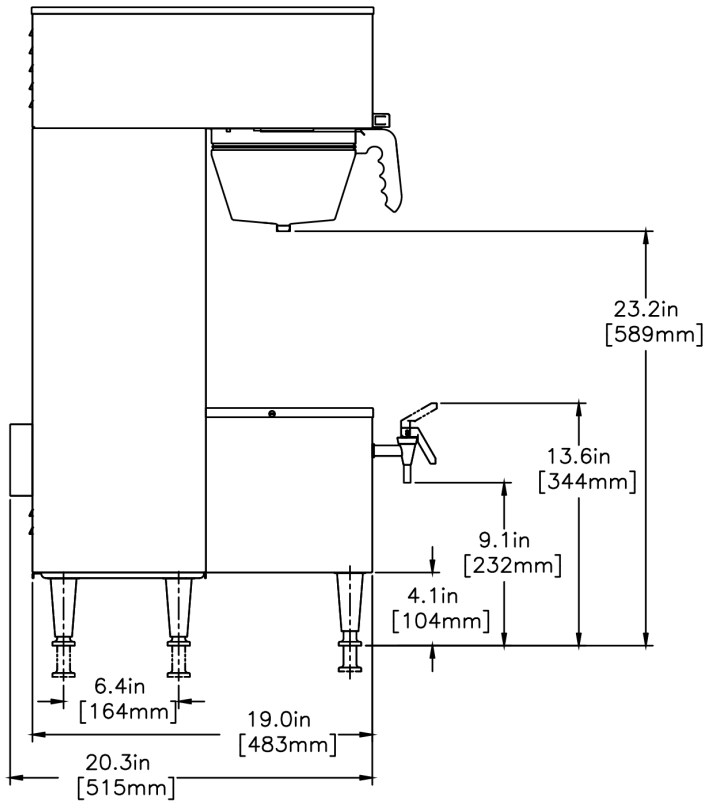
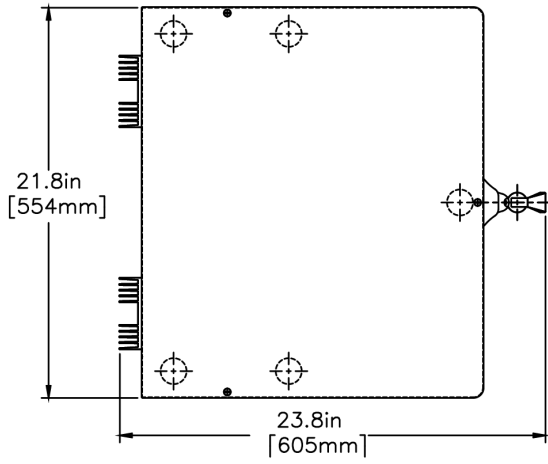













| | Unit | | | Shipping | | | | |
|---------|----------|----------|----------|----------|----------|----------|------------|------------|
| | Height | Width | Depth | Height | Width | Depth | Weight | Volume |
| English | 35.7 in. | 21.8 in. | 23.8 in. | 38.8 in. | 24.7 in. | 25.9 in. | 91.350 lbs | 14.360 ft³ |
| Metric | 90.7 cm | 55.4 cm | 60.5 cm | 98.4 cm | 62.7 cm | 65.9 cm | 41.436 kgs | 0.407 m³ |



BUNN® reserves the right to change specifications and product design without notice. Such revisions do not entitle the buyer to corresponding changes, improvements, additions or replacements for previously purchased equipment. For most current specifications and other info visit bunn.com.

Last Updated:
02/05/2026

Related Products & Accessories: DUAL TF DBC® SST 120/208V w/Fnl Locks(34600.0006)

| | | | | |
|--|---|--|---|---|
|  <p>FILTERS, GOURMET 500 500/1 50/CL</p> <p>Product #: 20138.1000</p> |  <p>FUNNEL ASSY, W/ INSERTS SMTF</p> <p>Product #: 32643.0000²</p> | <p>CARD ASSY, RECIPE TRANSFER (BRW)</p> <p>Product #: 34447.0016</p> |  <p>MHG, 120V BLK</p> <p>Product #: 35600.0022</p> | <p>KIT, PM-DUAL TF</p> <p>Product #: 39641.0000²</p> |
|  <p>TF SERVER, 1G DSG GEN3</p> <p>Product #: 42700.0200¹</p> |  <p>TF SERVER, 1G DSG GEN3 NOBASE</p> <p>Product #: 42700.0250¹</p> |  <p>TF SERVER, 1.5G DSG GEN3</p> <p>Product #: 42750.0200¹</p> |  <p>TF SERVER, 1.5G DSG GEN3 NOBASE</p> <p>Product #: 42750.0250¹</p> |  <p>TF SERVER, 1G MECH GEN3</p> <p>Product #: 44000.0200¹</p> |
|  <p>TF SERVER, 1G MECH GEN3 NOBASE</p> <p>Product #: 44000.0250¹</p> |  <p>TF SERVER, 1.5G MECH GEN3</p> <p>Product #: 44050.0200¹</p> |  <p>TF SERVER, 1.5G MECH NOBASE GEN3</p> <p>Product #: 44050.0250¹</p> |  <p>SYSTEM, WQ-55(3).2L</p> <p>Product #: 56000.0002¹</p> |  <p>SYSTEM, WQ-55(3).2</p> <p>Product #: 56000.0005¹</p> |

¹NSF Certified ²NSF Certified with spec sheet model listed ³NSF Certified under Solventum Purification ⁴NSF Certified under Mavea LLC ⁵NSF Certified under Zojirushi ⁶NSF Certified under Qins Inc ⁷NSF COMPONENT Certified



BUNN® reserves the right to change specifications and product design without notice. Such revisions do not entitle the buyer to corresponding changes, improvements, additions or replacements for previously purchased equipment. For most current specifications and other info visit bunn.com.

Last Updated:
02/05/2026

Related Products & Accessories: DUAL TF DBC® SST 120/208V w/Fnl Locks(34600.0006)



SYSTEM, WEQ-25(2).2

Product #: 56000.0028¹



SYSTEM, WEQ-35(3).2L

Product #: 56000.0034



CARTRIDGE, WQ-55
(3).2L

Product #: 56000.0102¹



CARTRIDGE, WQ-55(3).2

Product #: 56000.0105¹



CARTRIDGE, WEQ-25
(2).2

Product #: 56000.0124¹



CARTRIDGE, WEQ-35
(3).2L

Product #: 56000.0126¹



BUNN® reserves the right to change specifications and product design without notice. Such revisions do not entitle the buyer to corresponding changes, improvements, additions or replacements for previously purchased equipment. For most current specifications and other info visit bunn.com.

Last Updated:
02/05/2026

Serving & Holding Options: DUAL TF DBC® SST 120/208V w/Fnl Locks(34600.0006)



TF SERVER, DSG2
1G/3.8L

Product #: 42700.0000¹



TF SERVER, DSG2 1.5G
SST

Product #: 42750.0000¹



TF SERVER, DSG2 1.5G
BLK

Product #: 42750.0001¹



TF SERVER, DSG2 1.5G
CD

Product #: 42750.0003¹



TF SERVER, 1G/3.8L
MECH

Product #: 44000.0000¹



TF SERVER, 1.5G/5.7L
MECH

Product #: 44050.0000¹



TF SERVER, 1.5G/5.7L
MECH BLK

Product #: 44050.0001¹



BUNN® reserves the right to change specifications and product design without notice. Such revisions do not entitle the buyer to corresponding changes, improvements, additions or replacements for previously purchased equipment. For most current specifications and other info visit bunn.com.

Last Updated:
02/05/2026