

TF Server - Mechanical GEN3 Black

Height: 22.7" Width: 9.1" Depth: 13.0"
(57.7cm) (23.1cm) (33.0cm)



- Vacuum insulated to keep coffee hot for hours
- Ideal for use with Twin or Single Infusion Series Brewers
- Brew-through design with flip lid cover
- Soft-grip bail handle for easy transportation
- Self-locking stand allows for multiple brewing and serving options
- Large cup clearance allows for dispensing into cups, decanters and thermal carafes
- Integrated sight gauge assembly allows for easy cleaning
- Sturdy aluminum faucet guard keeps faucet area clean and protected
- Drip tray is easily removed for cleaning or to provide extra clearance for dispensing into pitchers
- Fast flow faucet

Agency:



Specifications

Product #: 44050.0203

Handle: Bail Handle

Dispense: Lever Action

Lid Color: Black

Additional Features

Holding Capacity

English	Metric
192 oz.	5.7 L

 **WARNING:**



BUNN® reserves the right to change specifications and product design without notice. Such revisions do not entitle the buyer to corresponding changes, improvements, additions or replacements for previously purchased equipment. For most current specifications and other info visit bunn.com.

Last Updated:
12/27/2022

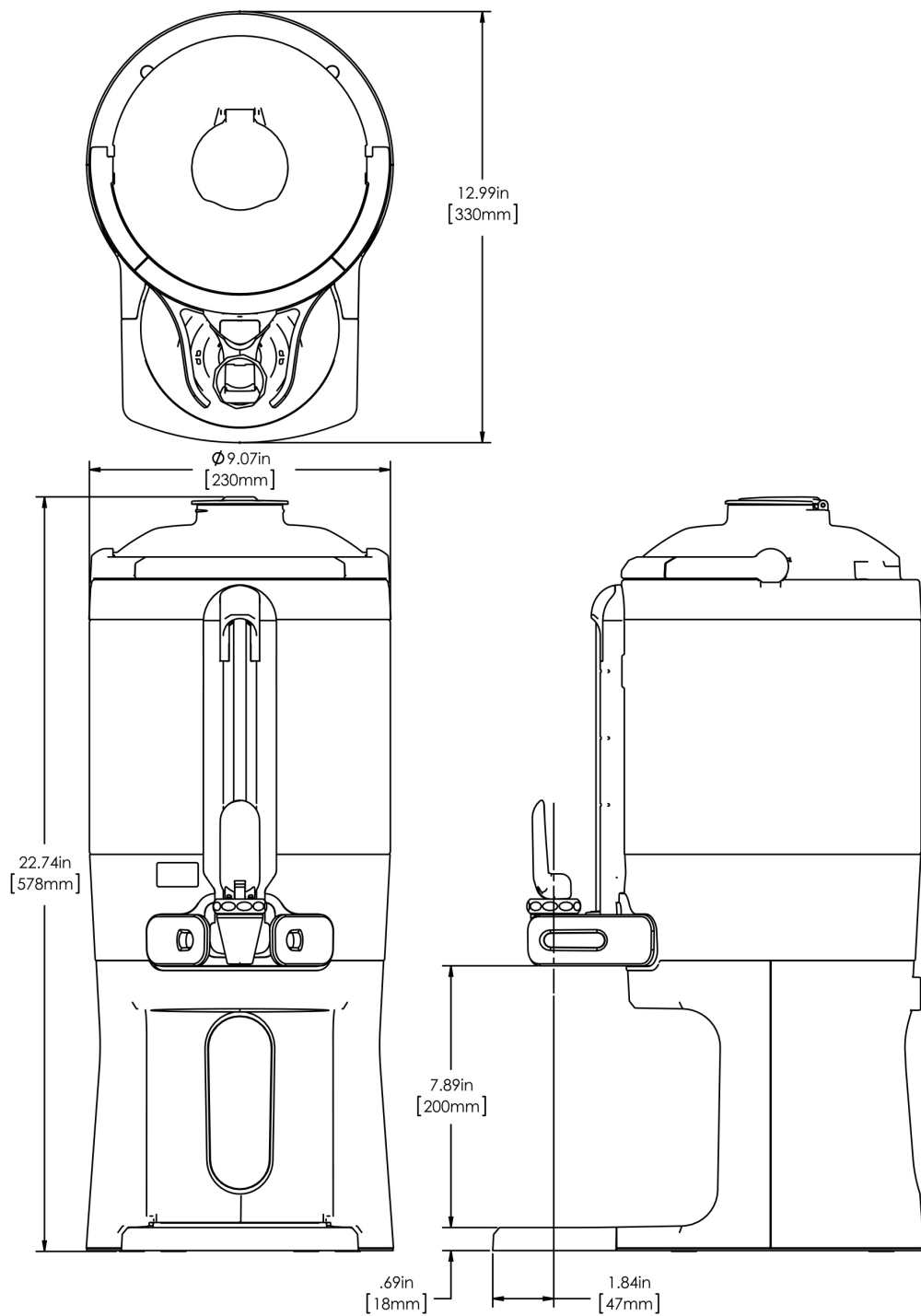

	Unit			Shipping				
	Height	Width	Depth	Height	Width	Depth	Weight	Volume
English	22.7 in.	9.1 in.	13.0 in.	15.3 in.	11.9 in.	25.2 in.	14.300 lbs	2.654 ft ³
Metric	57.7 cm	23.1 cm	33.0 cm	38.7 cm	30.3 cm	64.0 cm	6.486 kgs	0.075 m ³



BUNN® reserves the right to change specifications and product design without notice. Such revisions do not entitle the buyer to corresponding changes, improvements, additions or replacements for previously purchased equipment. For most current specifications and other info visit bunn.com.

Last Updated:
12/27/2022

Related Products & Accessories:TF Server - Mechanical GEN3 Black(44050.0203)

HANDLE, FAUCET 3.0
SHORT ORANGE

Product #: 51315.0003

HOLDER, SIGN TF-
SERVER

Product #: 53683.0004



STAND ASSY KIT, TF
SERVER

Product #: 54473.1000



BUNN® reserves the right to change specifications and product design without notice. Such revisions do not entitle the buyer to corresponding changes, improvements, additions or replacements for previously purchased equipment. For most current specifications and other info visit bunn.com.

Last Updated:
12/27/2022

Model Compatibility:TF Server - Mechanical GEN3 Black(44050.0203)

Serving and Holding selections are currently unavailable. Please contact your sales representative to find out more information.



BUNN® reserves the right to change specifications and product design without notice. Such revisions do not entitle the buyer to corresponding changes, improvements, additions or replacements for previously purchased equipment. For most current specifications and other info visit bunn.com.

Last Updated:
12/27/2022