

WQ-TWIN75(10)5

Height: 22.67" Width: 12.75" Depth: 6.00"
(57.6cm) (32.4cm) (15.2cm)



- Designed for high volume applications using a unique blend of catalytic coconut shell carbon rated up to 75,000 gallons each for a combined total of 150,000 gallons, this system reduces chlorine taste and odor for consistent, great tasting cold water and carbonated beverages
- Built-in by-pass indicators on filter head provide visual confirmation of the filter's internal integrity taking the guesswork out of the system's performance ensuring that only filtered water is being delivered to beverage equipment at all times
- Sanitary quick connect valve-in-head design simultaneously shuts off and vents water with ¼ turn, allowing for simple cartridge change-outs and maintenance times
- Unique modular filter head manifold design allows for simple installation, customization, and future system expansion
- Auto-leveling technology ensures perfect installation every time
- High capacity, low pressure drop system configuration
- Select filters NSF certified to Standard 42 for reduction of Sediment, Chlorine Taste and Odor and Chloramines
- Certified to NSF Standard 42 for Sediment, Chlorine Taste and Odor reduction
- Includes twin filter head assembly with manifold bracket, 3/4" MNPT fittings, 1/4" quick-connect rinse valve and commercial 0-120 PSI back-mounted pressure gauge

NOTE: Do not use with water that is microbiologically unsafe or of unknown quality without adequate disinfection before or after the system.

Specifications

Product #: 56000.0020

Cartridge Type: Quick Change

Application(s): Post Mix, Backroom Package/Combo System

Replacement Cartridge: 56000.0306

Filtration Type: Sediment, Lime, Chlorine Taste & Odor

Filter Change Frequency: Annual

Capacity

Micron Rating	Service Flow Rate	Water Filter Capacity Chlorine Reduction	Water Filter Capacity Chloramine Reduction	Water Filter Capacity Softening
5.0	10.0 gal/min (37.9 L/min)	150000 gal. (567801.6 L)	-	-

Plumbing Requirements

Inlet Connection	Outlet Connection	Min Operating Pressure	Max Operating Pressure	Min Operating Temperature	Max Operating Temperature
3/4 IN	3/4 IN	20 psi (138 kPa)	125 psi (862 kPa)	40°F(4°C)	100°F(38°C)

WARNING:



BUNN® reserves the right to change specifications and product design without notice. Such revisions do not entitle the buyer to corresponding changes, improvements, additions or replacements for previously purchased equipment. For most current specifications and other info visit bunn.com.

Last Updated:
01/16/2023

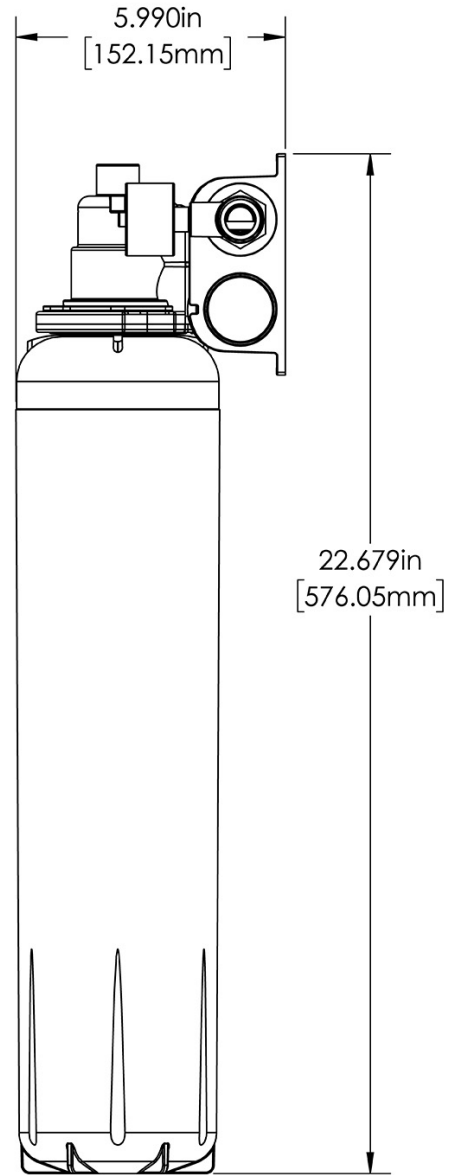
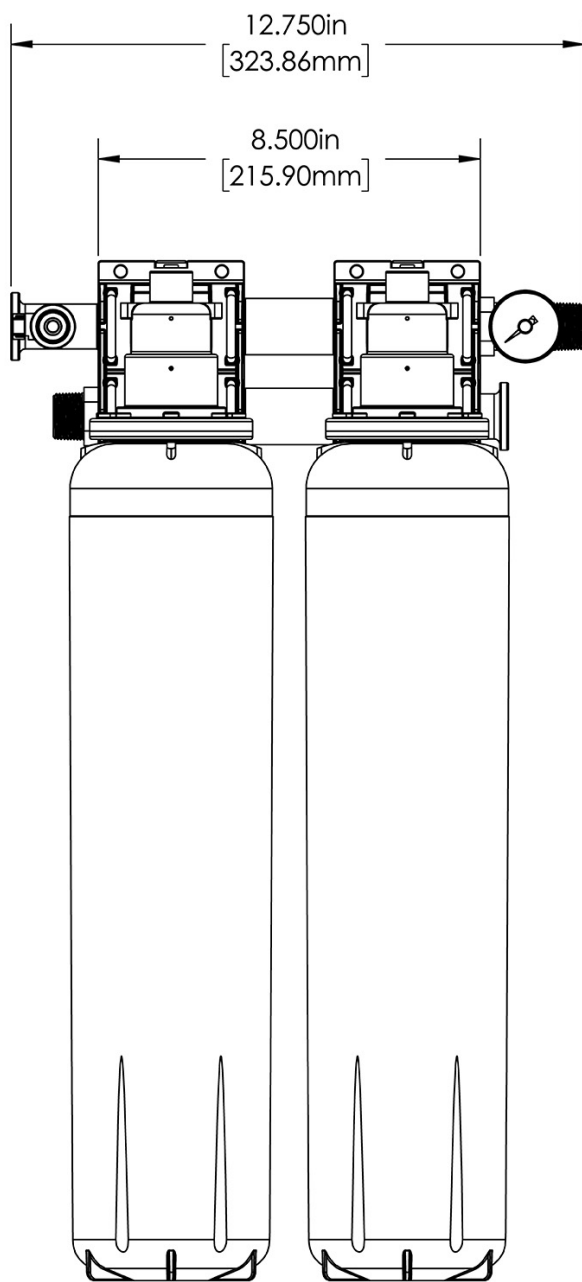

Dimensions of Filter System <i>(filter head with filter cartridge)</i>			Installed Dimensions <i>(Installation with wall mounting)</i>			Cartridge Dimensions <i>(filter cartridge only)</i>			
	Height	Width	Depth	Height	Width	Depth	Height	Width	Depth
English	22.67 in.	12.75 in.	6.00 in.	-	-	-	21.32 in.	4.53 in.	4.53 in.
Metric	57.6 cm	32.4 cm	15.2 cm	-	-	-	54.2 cm	11.5 cm	11.5 cm

Weight			Shipping				
	Dry	Wet	Height	Width	Depth	Weight	Volume
English	0.0 lbs	0.0 lbs	8.00 in.	18.00 in.	24.00 in.	12.250 lbs	-
Metric	-	-	20.3 cm	45.7 cm	61.0 cm	5.557 kgs	-

WARRANTY: BUNN High Performance Water Filtration Solutions Systems by BUNN® (excluding water filters and water treatment replacement cartridges) are covered by a limited warranty against defects in material and workmanship for a period of five years after date of purchase, under normal use and service, and when installed in accordance with manufacturer's recommendations outlined in the filtration systems owner's manual. BUNN replaceable elements (water treatment cartridges, filter elements, and feeder elements) are covered by a limited warranty against defects in material and workmanship for a period of one year after date of purchase or the remainder of the original warranty, whichever is longer. See printed warranty for full details. BUNN will provide a copy of the warranty upon request.



BUNN® reserves the right to change specifications and product design without notice. Such revisions do not entitle the buyer to corresponding changes, improvements, additions or replacements for previously purchased equipment. For most current specifications and other info visit bunn.com.

Last Updated:
01/16/2023

Related Products & Accessories: WQ-TWIN75(10)5(56000.0020)



MANIFOLD, WQ-TWIN

Product #: 56000.0209



CARTRIDGE, WQ-75(5)5

Product #: 56000.0306



BUNN® reserves the right to change specifications and product design without notice. Such revisions do not entitle the buyer to corresponding changes, improvements, additions or replacements for previously purchased equipment. For most current specifications and other info visit bunn.com.

Last Updated:
01/16/2023

Model Compatibility: WQ-TWIN75(10)5(56000.0020)

Serving and Holding selections are currently unavailable. Please contact your sales representative to find out more information.



BUNN® reserves the right to change specifications and product design without notice. Such revisions do not entitle the buyer to corresponding changes, improvements, additions or replacements for previously purchased equipment. For most current specifications and other info visit bunn.com.

Last Updated:
01/16/2023