

NITRON® Cold Draft Single 1-Gal Scholle

Height: 34.0" Width: 10.0" Depth: 28.4"
(86.4cm) (25.4cm) (72.1cm)



- Using a 1-gallon Scholle concentrate BIB, serve a single coffee or tea as both Nitro and Still
- Patented BUNN gas infusion technology can produce up to 3 minutes of cascading micro-bubbles
- Patented High Intensity® mixing chamber assures a perfectly blended finished beverage, from cup to cup
- Mounted on standard 3/8"-16 UNC threads, chrome plated brass tap handles are interchangeable with custom handles for a more personalized look
- Automatic water bath fill maintains water bath level for optimal cold beverage capacity
- Sleek, all-black door complements any commercial setting
- At a rate of one 16oz drink per minute, can dispense 60 drinks before exceeding 41°F (using 75°F incoming water)
- Refrigerated product cabinet protects flavor integrity and product life
- Large dispense area accommodates taller cups and carafes up to 8.76"
- Service-friendly design makes set-up and maintenance simple
- Gas module not included with this model. A tank regulator is required

Agency:



Specifications

Product #: 51600.0042

Flavors: 1 Flavor

Product Ratio: 4:1-12:1

Connector: Scholle

Water Access: Plumbed

Finish: Black

Door: Lit

Refrigerant: R-134A

Additional Features

Electrical & Capacity

Volts*	Amps	Watts	Cord Attached	Plug Type	8oz cups/hr 236ml cups/hr	Input H ₂ O Temp.	Phase	# Wires plus Ground	Hertz
120	6	720	Yes	NEMA 5-15P	-	60°F (15.5°C)	1	2	60

*When a BUNN is machine rated 120/208-240V, 120/208V or 120/240V, the higher voltage is the supply voltage needed to power the machine. The 120V is there to supply power to some components rated 120V in the machine, but it is not the supply voltage and would not power the machine if the machine is marked with the before mentioned ratings.

Plumbing Requirements

PSI	kPa	Fitting Supplied	Water Flow Required (GPM)
30-90	207-621	3/8" Male Flare Fitting	0.94

CAD Drawings

2D	Revit	KLC
●	●	

WARNING:



BUNN® reserves the right to change specifications and product design without notice. Such revisions do not entitle the buyer to corresponding changes, improvements, additions or replacements for previously purchased equipment. For most current specifications and other info visit bunn.com.

Last Updated:
03/04/2026

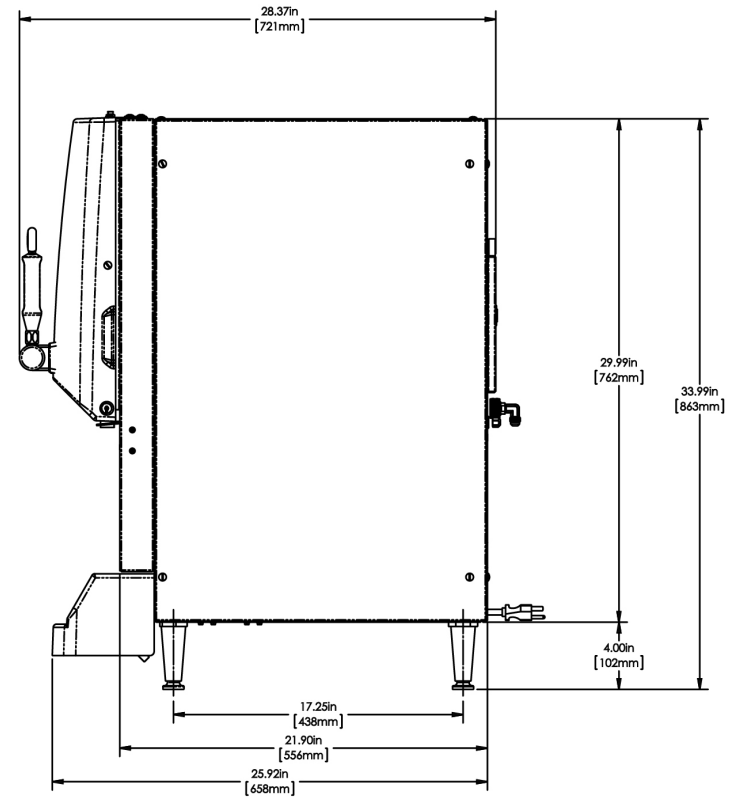
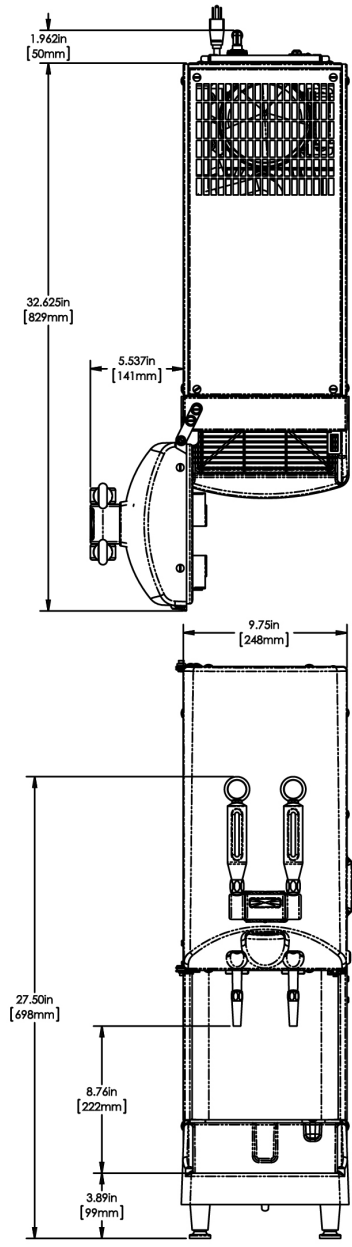

Unit			Shipping					
	Height	Width	Depth	Height	Width	Depth	Weight	Volume
English	34.0 in.	10.0 in.	28.4 in.	43.7 in.	22.8 in.	30.5 in.	130.000 lbs	17.586 ft³
Metric	86.4 cm	25.4 cm	72.1 cm	111.0 cm	57.9 cm	77.5 cm	58.968 kgs	0.498 m³







BUNN® reserves the right to change specifications and product design without notice. Such revisions do not entitle the buyer to corresponding changes, improvements, additions or replacements for previously purchased equipment. For most current specifications and other info visit bunn.com.

Last Updated: 03/04/2026

Related Products & Accessories: NITRON® Cold Draft Single 1-Gal Scholle(51600.0042)

 <p>SANITIZER,KAY-5 (BOX-200 PKTS)</p> <hr/> <p>Product #: 24634.0000</p>	 <p>SANITIZER,KAY-5 (BOX-50 PKTS)</p> <hr/> <p>Product #: 24634.0001</p>	 <p>KIT, TST 2 VALVE NITRON</p> <hr/> <p>Product #: 45536.1004</p>	 <p>KIT, PRIMARY N2 REGULATOR</p> <hr/> <p>Product #: 54060.0000²</p>	 <p>TUBE ASSY, CBDSPCT SCHOLLE SR Y-FITING</p> <hr/> <p>Product #: 55011.0005²</p>
--	---	---	---	--

 <p>FITTING ASSEMBLY, SCHOLLE QUICK CONNECT</p> <hr/> <p>Product #: 55324.0000²</p>	 <p>TUBE ASSEMBLY, EXTENSION QUICK CONNECT</p> <hr/> <p>Product #: 55325.0000²</p>	 <p>NITRON GAS MODULE, 120V 60HZ</p> <hr/> <p>Product #: 55660.0005¹</p>	 <p>KIT, FILTERS NGM</p> <hr/> <p>Product #: 56333.0000</p>	 <p>KIT, SWITCH COVER - 2 VALVE CBDSPCT</p> <hr/> <p>Product #: 58139.0000</p>
---	--	--	--	---

¹NSF Certified ²NSF Certified with spec sheet model listed ³NSF Certified under Solventum Purification ⁴NSF Certified under Mavea LLC ⁵NSF Certified under Zojirushi ⁶NSF Certified under Qins Inc ⁷NSF COMPONENT Certified



BUNN® reserves the right to change specifications and product design without notice. Such revisions do not entitle the buyer to corresponding changes, improvements, additions or replacements for previously purchased equipment. For most current specifications and other info visit bunn.com.

Last Updated:
03/04/2026

Serving & Holding Options: NITRON® Cold Draft Single 1-Gal Scholle(51600.0042)

Serving and Holding selections are currently unavailable. Please contact your sales representative to find out more information.

¹NSF Certified ²NSF Certified with spec sheet model listed ³NSF Certified under Solventum Purification ⁴NSF Certified under Mavea LLC ⁵NSF Certified under Zojirushi ⁶NSF Certified under Qins Inc ⁷NSF COMPONENT Certified



BUNN® reserves the right to change specifications and product design without notice. Such revisions do not entitle the buyer to corresponding changes, improvements, additions or replacements for previously purchased equipment. For most current specifications and other info visit bunn.com.

Last Updated:
03/04/2026