

EQHP-25

Height: 0.00" Width: 0.00" Depth: 0.00"
(0.0cm) (0.0cm) (0.0cm)



- Filter cartridges incorporate carbon block media and require no pre-activation
- Equipment protection from reduced sediment particles that can clog the sprayhead
- Consistent brewed coffee and tea from water with reduced sediment and chlorine taste and odor
- Pre-filter offers exceptional sediment holding capacity and particle reduction to 0.2 microns
- Certified by NSF to Standard 53 for cyst reduction
- Incorporates multi-zone pharmaceutical grade pleated nylon pre-filter
- Sanitary quick connect valve-in-head design simultaneously shuts off and vents water with 1/4 turn, allowing for simple and trouble-free cartridge change-outs

NOTE: Do not use with water that is microbiologically unsafe or of unknown quality without adequate disinfection before or after the system.

Agency:



Systems and other related parts are certified to NSF International NSF/ANSI Standard 42 and/or NSF International NSF/ANSI Standard 53 as marked.

Specifications

Product #: 39000.0005

Cartridge Type: Sanitary Quick Connect

Application(s):

Replacement Cartridge:

Filtration Type:

Filter Change Frequency:

Capacity

Micron Rating	Service Flow Rate	Water Filter Capacity Chlorine Reduction	Water Filter Capacity Chloramine Reduction	Water Filter Capacity Softening
0.2	2.1 gal/min (7.9 L/min)	25000 gal. (94633.6 L)	-	-

Plumbing Requirements

Inlet Connection	Outlet Connection	Min Operating Pressure	Max Operating Pressure	Min Operating Temperature	Max Operating Temperature
3/8 IN FNPT	3/8 IN FNPT		100 psi (689 kPa)		100°F(38°C)

WARNING:



BUNN® reserves the right to change specifications and product design without notice. Such revisions do not entitle the buyer to corresponding changes, improvements, additions or replacements for previously purchased equipment. For most current specifications and other info visit bunn.com.

Last Updated:
04/29/2022

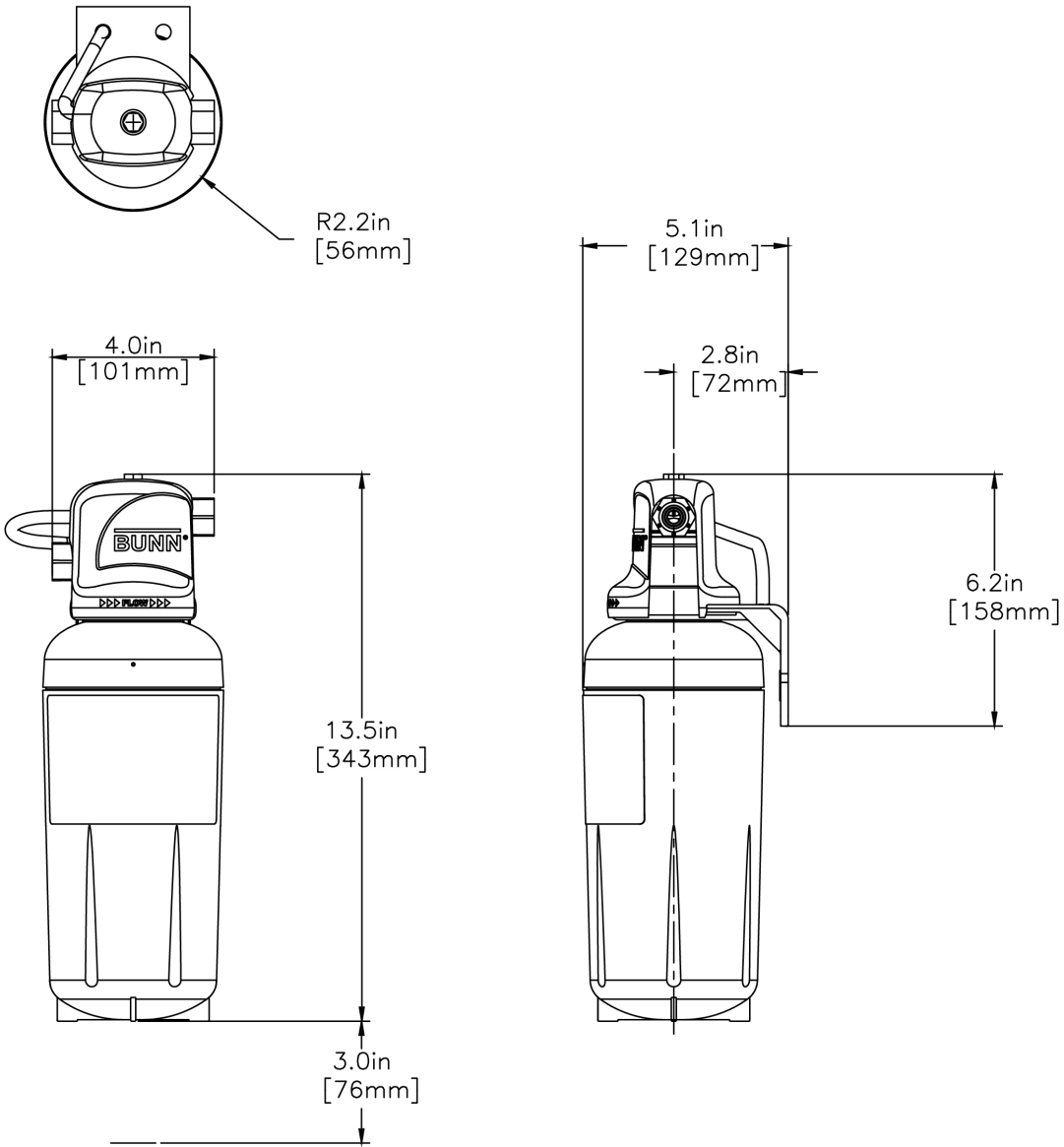

Dimensions of Filter System <i>(filter head with filter cartridge)</i>			Installed Dimensions <i>(Installation with wall mounting)</i>			Cartridge Dimensions <i>(filter cartridge only)</i>			
	Height	Width	Depth	Height	Width	Depth	Height	Width	Depth
English	-	-	-	-	-	-	-	-	-
Metric	-	-	-	-	-	-	-	-	-

Weight			Shipping				
	Dry	Wet	Height	Width	Depth	Weight	Volume
English	0.0 lbs	0.0 lbs	23.00 in.	5.00 in.	5.00 in.	3.600 lbs	-
Metric	-	-	58.4 cm	12.7 cm	12.7 cm	1.633 kgs	-

WARRANTY: BUNN High Performance Water Filtration Solutions Systems by BUNN® (excluding water filters and water treatment replacement cartridges) are covered by a limited warranty against defects in material and workmanship for a period of five years after date of purchase, under normal use and service, and when installed in accordance with manufacturer's recommendations outlined in the filtration systems owner's manual. BUNN replaceable elements (water treatment cartridges, filter elements, and feeder elements) are covered by a limited warranty against defects in material and workmanship for a period of one year after date of purchase or the remainder of the original warranty, whichever is longer. See printed warranty for full details. BUNN will provide a copy of the warranty upon request.



BUNN® reserves the right to change specifications and product design without notice. Such revisions do not entitle the buyer to corresponding changes, improvements, additions or replacements for previously purchased equipment. For most current specifications and other info visit bunn.com.

Last Updated:
04/29/2022

Related Products & Accessories: EQHP-25(39000.0005)



GAUGE, WATER FILTER
EQHP

Product #: 39000.0100



WATER FILTER HEAD,
EQHP-VHD

Product #: 39000.1000



CARTRIDGE,
EQHP-25CRTG

Product #: 39000.1005



BUNN® reserves the right to change specifications and product design without notice. Such revisions do not entitle the buyer to corresponding changes, improvements, additions or replacements for previously purchased equipment. For most current specifications and other info visit bunn.com.

Last Updated:
04/29/2022

Model Compatibility: EQHP-25(39000.0005)

Serving and Holding selections are currently unavailable. Please contact your sales representative to find out more information.



BUNN® reserves the right to change specifications and product design without notice. Such revisions do not entitle the buyer to corresponding changes, improvements, additions or replacements for previously purchased equipment. For most current specifications and other info visit bunn.com.

Last Updated:
04/29/2022