

NITRON®, 230V COLD DRAFT ALL-NITRO

Height: 34.0" Width: 9.8" Depth: 29.8"
(86.4cm) (24.9cm) (75.7cm)



- Serve two different coffees or teas as nitrogenated beverages using 3.78 Liter bag-in-box (BIB) concentrates or refillable containers
- Patented BUNN gas infusion technology can produce up to 3 minutes of cascading micro-bubbles
- Patented High Intensity® mixing chamber assures a perfectly blended finished beverage, from cup to cup
- Chrome-plated brass tap handles and nitro stout nozzles provide the quality-oriented craft experience of serving a premium beverage on tap
- Automatic water bath fill maintains water bath level for optimal cold beverage capacity
- Sleek, all-black door complements any commercial setting
- At a rate of one 473 ml drink per minute, can dispense 60 drinks before exceeding 5°C (@23.9°C incoming water)
- Refrigerated product cabinet protects flavor integrity and product life
- Large dispense area accommodates taller cups and carafes up to 22.3 cm
- Service-friendly design makes set-up and maintenance simple

Tank Regulator Required

Agency:

Specifications

Product #: 51600.0034

Flavors: 2 Flavors

Product Ratio: 4:1-12:1

Connector: Ball-valve

Water Access: Plumbed

Finish: Black

Door: Lit

Refrigerant: R-134A

Additional Features

Electrical & Capacity

Volts*	Amps	Watts	Cord Attached	Plug Type	8oz cups/hr 236ml cups/hr	Input H ₂ O Temp.	Phase	# Wires plus Ground	Hertz
220-240	2.25-2.75	410-520	Yes/	-	-	60°F (15.5°C)	1	2	50-60

*When a BUNN is machine rated 120/208-240V, 120/208V or 120/240V, the higher voltage is the supply voltage needed to power the machine. The 120V is there to supply power to some components rated 120V in the machine, but it is not the supply voltage and would not power the machine if the machine is marked with the before mentioned ratings.

Plumbing Requirements

PSI	kPa	Fitting Supplied	Water Flow Required (GPM)
30-90	207-621	3/8" Male Flare Fitting	0.94

CAD Drawings

2D	Revit	KLC
●	●	●

WARNING:



BUNN® reserves the right to change specifications and product design without notice. Such revisions do not entitle the buyer to corresponding changes, improvements, additions or replacements for previously purchased equipment. For most current specifications and other info visit bunn.com.

Last Updated:
11/17/2025

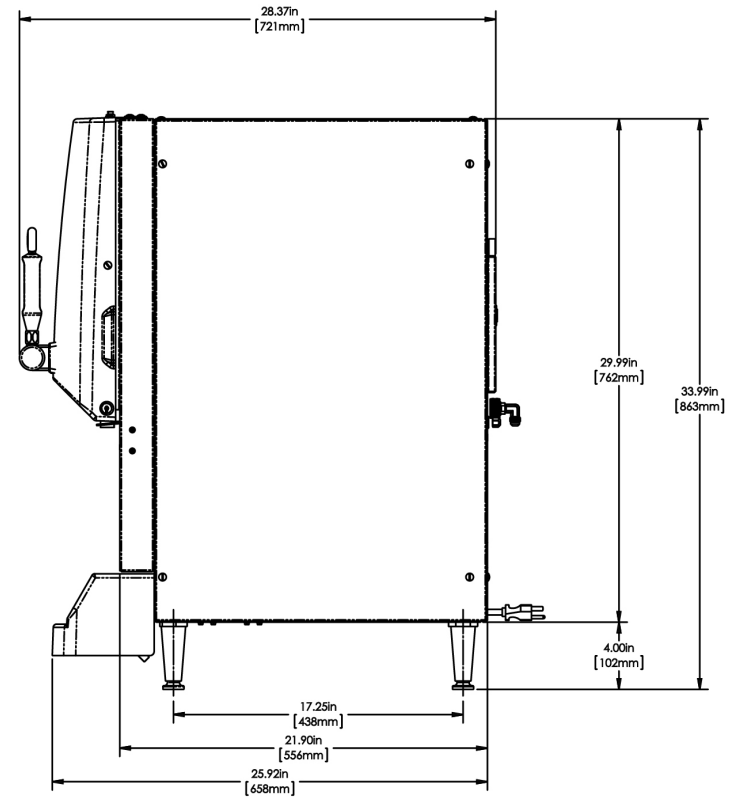
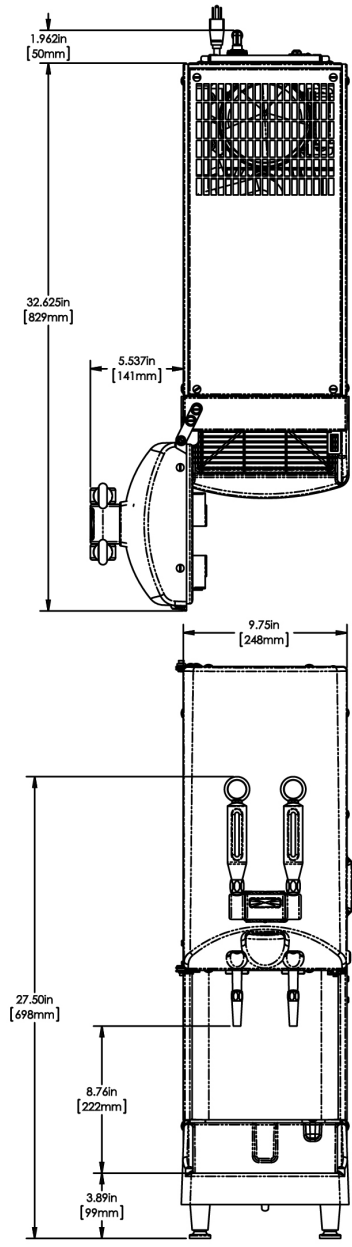





Unit			Shipping					
	Height	Width	Depth	Height	Width	Depth	Weight	Volume
English	34.0 in.	9.8 in.	29.8 in.	43.7 in.	22.8 in.	30.5 in.	118.120 lbs	17.543 ft³
Metric	86.4 cm	24.9 cm	75.7 cm	111.0 cm	57.8 cm	77.5 cm	53.579 kgs	0.497 m³





BUNN® reserves the right to change specifications and product design without notice. Such revisions do not entitle the buyer to corresponding changes, improvements, additions or replacements for previously purchased equipment. For most current specifications and other info visit bunn.com.

Last Updated: 11/17/2025

Related Products & Accessories: NITRON®, 230V COLD DRAFT ALL-NITRO(51600.0034)

 <p>SANITIZER,KAY-5 (BOX-200 PKTS)</p> <hr/> <p>Product #: 24634.0000</p>	 <p>SANITIZER,KAY-5 (BOX-50 PKTS)</p> <hr/> <p>Product #: 24634.0001</p>	 <p>CONTAINER ASSY, REFILLABLE</p> <hr/> <p>Product #: 39302.0000²</p>	 <p>KIT, TST 2 VALVE NITRON</p> <hr/> <p>Product #: 45536.1004</p>	 <p>SYSTEM, WQ-55(2)5</p> <hr/> <p>Product #: 56000.0004¹</p>
--	---	--	---	---

 <p>SYSTEM, WQ-60(3.5).2C</p> <hr/> <p>Product #: 56000.0014¹</p>	 <p>SYSTEM, WEQ-10(1.5)5</p> <hr/> <p>Product #: 56000.0027¹</p>	 <p>SYSTEM, WEQ-18(2).2C</p> <hr/> <p>Product #: 56000.0036¹</p>	 <p>CARTRIDGE, WQ-55(2)5</p> <hr/> <p>Product #: 56000.0104¹</p>	 <p>CARTRIDGE, WQ-60 (3.5).2C</p> <hr/> <p>Product #: 56000.0114¹</p>
---	--	--	--	---

 <p>CARTRIDGE, WEQ-10 (1.5)5</p> <hr/> <p>Product #: 56000.0122¹</p>	 <p>CARTRIDGE, WEQ-18 (2).2C</p> <hr/> <p>Product #: 56000.0128¹</p>	<p>KIT, FILTERS NGM</p> <hr/> <p>Product #: 56333.0000</p>
--	--	--

¹NSF Certified ²NSF Certified with spec sheet model listed ³NSF Certified under Solventum Purification ⁴NSF Certified under Mavea LLC ⁵NSF Certified under Zojirushi ⁶NSF Certified under Qins Inc ⁷NSF COMPONENT Certified



BUNN® reserves the right to change specifications and product design without notice. Such revisions do not entitle the buyer to corresponding changes, improvements, additions or replacements for previously purchased equipment. For most current specifications and other info visit bunn.com.

Last Updated:
11/17/2025

Serving & Holding Options: NITRON®, 230V COLD DRAFT ALL-NITRO(51600.0034)

Serving and Holding selections are currently unavailable. Please contact your sales representative to find out more information.

¹NSF Certified ²NSF Certified with spec sheet model listed ³NSF Certified under Solventum Purification ⁴NSF Certified under Mavea LLC ⁵NSF Certified under Zojirushi ⁶NSF Certified under Qins Inc ⁷NSF COMPONENT Certified



BUNN® reserves the right to change specifications and product design without notice. Such revisions do not entitle the buyer to corresponding changes, improvements, additions or replacements for previously purchased equipment. For most current specifications and other info visit bunn.com.

Last Updated:
11/17/2025