

AXIOM®-DV-TC

Height: 17.8" Width: 9.0" Depth: 22.5"
(45.2cm) (22.9cm) (57.2cm)



- Adjusts automatically to varying water pressure
- For high lime areas, BrewLOGIC® technology calculates flow rate and adjusts brew time to maintain consistent pot levels
- Electronic diagnostics and built-in tank drain make service easier
- Ensure coffee quality with programming for brew level, cold brew lock-out and tank temperature, set easily from the front of the machine
- Coffee extraction controlled with programmable pre-infusion, pulse brew and digital temperature control
- Large 200oz. (5.9L) tank provides back-to-back brewing capacity
- Accepts thermal carafe up to 8.5" (21.6 cm) tall
- Energy-saver mode reduces tank temperature during idle periods
- Hot water faucet
- SplashGard® funnel deflects hot liquids away from the hand
- Dual voltage adaptable (Can operate at 120V/15 amp or 120/208-240V/20 amp)
- Use in quick turn environments where high quality coffee is continuously refreshed
- PROP 65 Warning Decal included in packaging with equipment
- Servers not included unless otherwise noted

Server(s) sold separately

Agency:



Specifications

Product #: 38700.0011

Faucet: Upper

Water Access: Plumbed

Finish: Stainless

Funnel: Black Plastic

Additional Features

DBC

Electrical & Capacity

Volts*	Amps	Watts	Cord Attached	Plug Type	8oz cups/hr 236ml cups/hr	Input H ₂ O Temp.	Phase	# Wires plus Ground	Hertz
120	12.5	1500	Yes	NEMA 5-15P	67	60°F (15.5°C)	1	2	60
120/208	13	2680	-	N/A	121	60°F (15.5°C)	1	3	60
120/240	15	3550	-	N/A	121	60°F (15.5°C)	1	3	60

*When a BUNN is machine rated 120/208-240V, 120/208V or 120/240V, the higher voltage is the supply voltage needed to power the machine. The 120V is there to supply power to some components rated 120V in the machine, but it is not the supply voltage and would not power the machine if the machine is marked with the before mentioned ratings.

Plumbing Requirements

PSI	kPa	Fitting Supplied	Water Flow Required (GPM)
20-90	138-621	1/4" Male Flare Fitting	-

CAD Drawings

2D	Revit	KLC
●		

WARNING: This product can expose you to chemicals including Bisphenol A (BPA), which is known to the State of California to cause birth defects or other reproductive harm. For more information go to www.P65Warnings.ca.gov



BUNN® reserves the right to change specifications and product design without notice. Such revisions do not entitle the buyer to corresponding changes, improvements, additions or replacements for previously purchased equipment. For most current specifications and other info visit bunn.com.

Last Updated:
04/08/2026

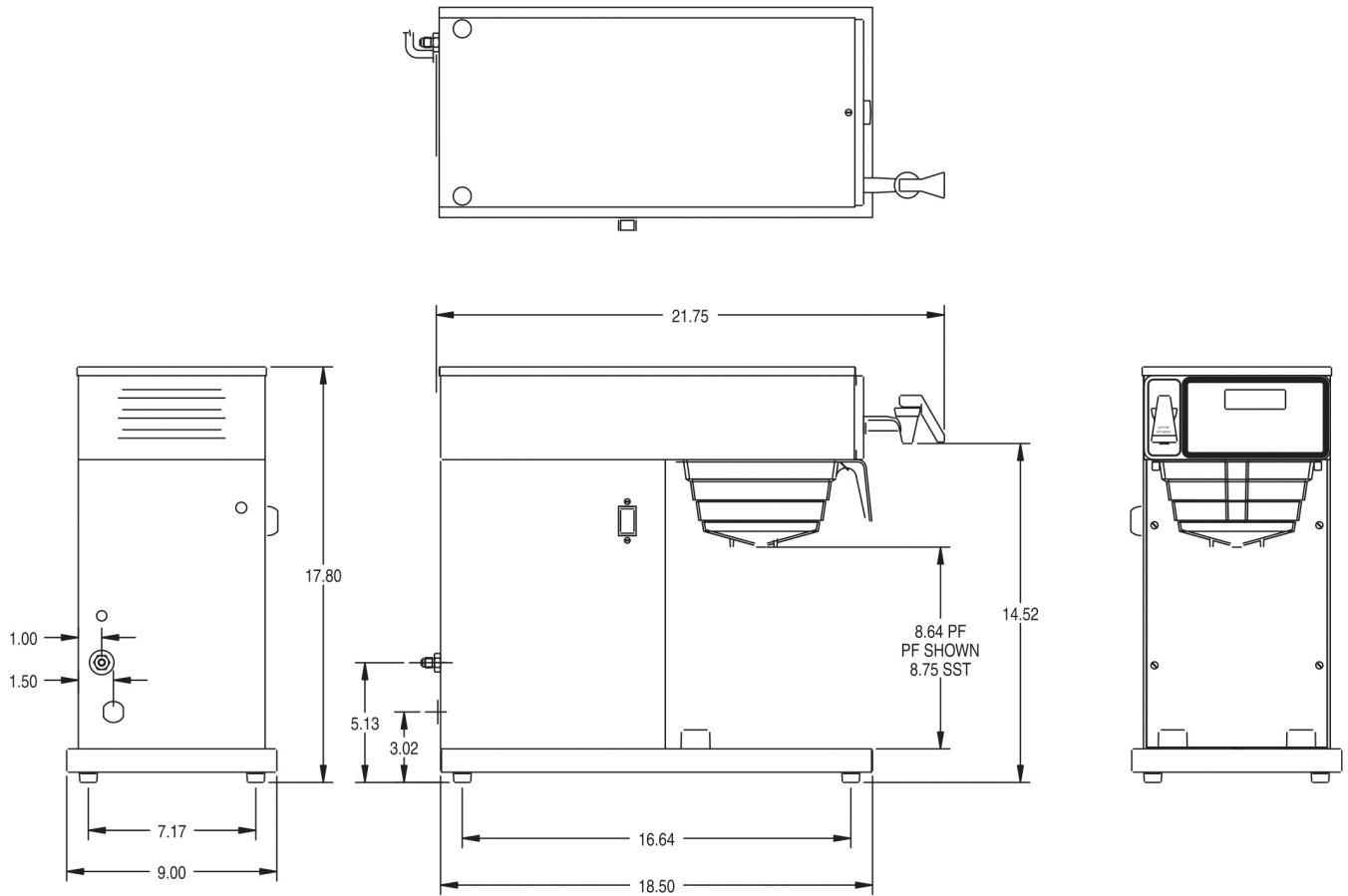











Unit			Shipping					
	Height	Width	Depth	Height	Width	Depth	Weight	Volume
English	17.8 in.	9.0 in.	22.5 in.	24.8 in.	11.9 in.	25.9 in.	31.650 lbs	4.401 ft ³
Metric	45.2 cm	22.9 cm	57.2 cm	62.9 cm	30.2 cm	65.7 cm	14.356 kgs	0.125 m ³



BUNN® reserves the right to change specifications and product design without notice. Such revisions do not entitle the buyer to corresponding changes, improvements, additions or replacements for previously purchased equipment. For most current specifications and other info visit bunn.com.

Last Updated:
04/08/2026

Related Products & Accessories: AXIOM®-DV-TC(38700.0011)

 <p>FUNNEL W/DECAL,PPK NAR BLK(SM)</p> <p>Product #: 02774.0011²</p>	 <p>FUNNEL W/DECAL,PPK NAR BLK(LG)</p> <p>Product #: 04274.0012²</p>	 <p>FILTERS,REGULAR1M 500/2 50/CL</p> <p>Product #: 20115.0000</p>	 <p>FUNNEL ASSY, SST-BLK HDL(7.12)</p> <p>Product #: 20216.0000²</p>	 <p>FUNNEL W/DECALS, BLACK PLASTIC</p> <p>Product #: 20583.0003²</p>
 <p>FUNNEL ASSY, SST-PP BLK HDL</p> <p>Product #: 29151.0000²</p>	 <p>FUNNEL ASSY,SST-PP ORANGE HDL</p> <p>Product #: 29151.0001²</p>	 <p>WATER FILTER SYSTEM,EQ-17-TL</p> <p>Product #: 30200.1000³</p>	 <p>WATER FILTER,IN LINE ED-17-TL</p> <p>Product #: 30201.1001³</p>	 <p>CARAFE, THERMALSEAMLESS 1.9L BLK</p> <p>Product #: 51746.0001⁶</p>
 <p>CARAFE,THRML SEAMLESS 1.9L BLK & ORN LID</p> <p>Product #: 51746.0003⁶</p>	 <p>CARAFE, THERMAL SEAMLESS 1.9L BLK 12/ CS</p> <p>Product #: 51746.0101⁶</p>	 <p>SYSTEM, WEQ-10(1.5)5L</p> <p>Product #: 56000.0024¹</p>	 <p>CARTRIDGE, WEQ-10 (1.5)5L</p> <p>Product #: 56000.0121¹</p>	 <p>CARTRIDGE, WEQ-10.3 (1.67)5L</p> <p>Product #: 56000.0137¹</p>

¹NSF Certified ²NSF Certified with spec sheet model listed ³NSF Certified under Solventum Purification ⁴NSF Certified under Vivreau Ltd ⁵NSF Certified under Zojirushi ⁶NSF Certified under Qins Inc ⁷NSF COMPONENT Certified



BUNN® reserves the right to change specifications and product design without notice. Such revisions do not entitle the buyer to corresponding changes, improvements, additions or replacements for previously purchased equipment. For most current specifications and other info visit bunn.com.

Last Updated:
04/08/2026

Serving & Holding Options: AXIOM®-DV-TC(38700.0011)



THERMAL CARAFE, BLK
1.9L 12PK

Product #: 36029.0000⁵

Mfr#:SH-DE19A



THERMAL CARAFE, BLK
1.83 L 1PK

Product #: 36029.0001⁵

Mfr#:SH-DE19A



THERMAL CARAFE,ORN
1.9L 12PK

Product #: 36252.0000⁵

Mfr#:SH-DE19A



THERMAL CARAFE,ORN
1.9L 1PK

Product #: 36252.0001⁵

Mfr#:SH-DE19A



CARAFE,SST 1.9L SHRT
BLK 1

Product #: 40163.0000⁶

¹NSF Certified ²NSF Certified with spec sheet model listed ³NSF Certified under Solventum Purification ⁴NSF Certified under Vivreau Ltd ⁵NSF Certified under Zojirushi ⁶NSF Certified under Qins Inc ⁷NSF COMPONENT Certified



BUNN® reserves the right to change specifications and product design without notice. Such revisions do not entitle the buyer to corresponding changes, improvements, additions or replacements for previously purchased equipment. For most current specifications and other info visit bunn.com.

Last Updated:
04/08/2026