

WAVE COMBO

Height: 17.4" Width: 9.7" Depth: 17.8"
(44.2cm) (24.6cm) (45.2cm)

- BrewMETER® allows automatic programming of pulse routine
- Adjustable legs to accommodate up to 3.0L lever action and 2.5L push button BUNN airpots and thermal servers
- Brew into 1.9L thermal carafe using the slide-out booster tray
- Four-digit LED read-out for simple programming
- Utilize the same LED read-out for brewer status (Ready, Heating, Brewing)
- SmartWAVE technology increases turbulence in the brew funnel
- Energy-saver mode reduces tank temperature during idle periods
- Ensures coffee brew quality with cold brew lock out capability
- SplashGard® tea and coffee funnels (included) deflect hot liquids away from the hand
- Iced Tea: 35oz concentrate, 90oz dilution.
- Servers not included unless otherwise noted



 Server(s) sold separately

Agency:



Specifications

Product #: 39900.0020

Funnel: Translucent Tea Funnel

Water Access: Plumbed

Finish: Stainless

Funnel: Black Plastic

Additional Features

BrewMETER

Electrical & Capacity

Volts*	Amps	Watts	Cord Attached	Plug Type	8oz cups/hr 236ml cups/hr	Input H ₂ O Temp.	Phase	# Wires plus Ground	Hertz
120	11.3	1350	Yes	NEMA 5-15P	62	60°F (15.5°C)	1	2	60

*When a BUNN is machine rated 120/208-240V, 120/208V or 120/240V, the higher voltage is the supply voltage needed to power the machine. The 120V is there to supply power to some components rated 120V in the machine, but it is not the supply voltage and would not power the machine if the machine is marked with the before mentioned ratings.

Plumbing Requirements

PSI	kPa	Fitting Supplied	Water Flow Required (GPM)
20-90	138-621	1/4" Male Flare Fitting	-

CAD Drawings

2D	Revit	KLC
●		

 **WARNING:**



BUNN® reserves the right to change specifications and product design without notice. Such revisions do not entitle the buyer to corresponding changes, improvements, additions or replacements for previously purchased equipment. For most current specifications and other info visit bunn.com.

Last Updated:
01/16/2026

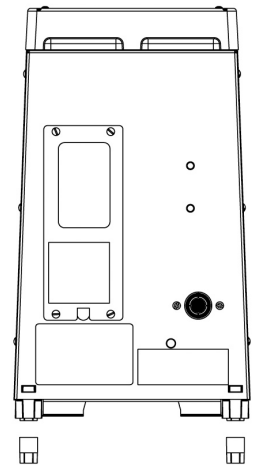
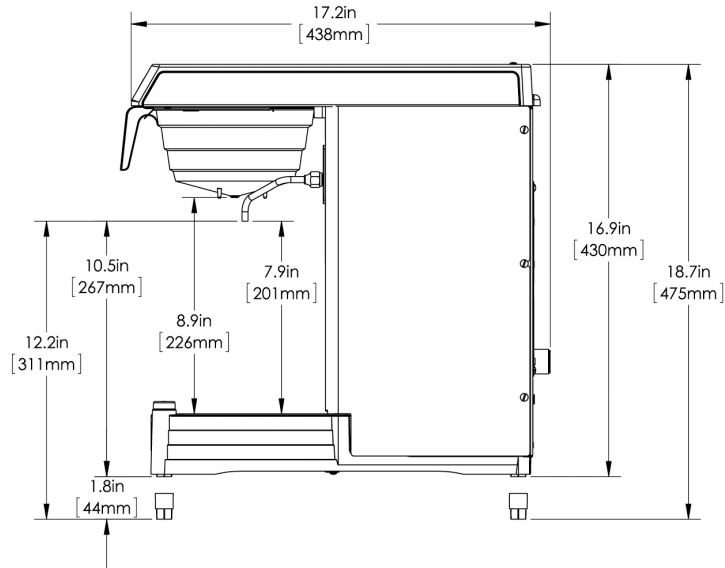
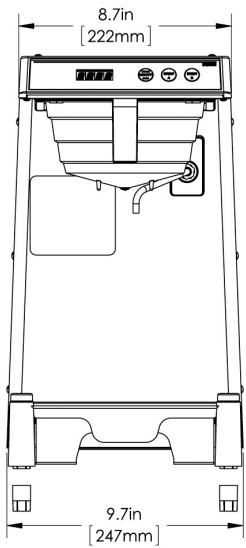
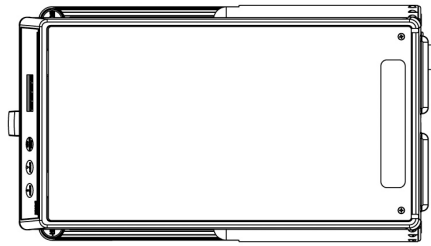



	Unit			Shipping				
	Height	Width	Depth	Height	Width	Depth	Weight	Volume
English	17.4 in.	9.7 in.	17.8 in.	19.5 in.	12.4 in.	19.5 in.	24.500 lbs	2.723 ft ³
Metric	44.2 cm	24.6 cm	45.2 cm	49.5 cm	31.4 cm	49.5 cm	11.113 kgs	0.077 m ³



BUNN® reserves the right to change specifications and product design without notice. Such revisions do not entitle the buyer to corresponding changes, improvements, additions or replacements for previously purchased equipment. For most current specifications and other info visit bunn.com.

Last Updated:
01/16/2026

Related Products & Accessories:WAVE COMBO(39900.0020)

 <p>FUNNEL W/DECAL,PPK NAR BLK(SM)</p> <p>Product #: 02774.0011²</p>	 <p>FUNNEL ASSY,W/TIP & SCREEN</p> <p>Product #: 03021.0016²</p>	 <p>FUNNEL W/DECAL,PPK NAR BLK(LG)</p> <p>Product #: 04274.0012²</p>	 <p>FILTERS,REGULAR1M 500/2 50/CL</p> <p>Product #: 20115.0000</p>	 <p>FUNNEL ASSY, SST-BLK HDL(7.12)</p> <p>Product #: 20216.0000²</p>
 <p>FUNNEL W/DECALS, BLACK PLASTIC</p> <p>Product #: 20583.0003²</p>	 <p>FUNNEL ASSY, SST-PP BLK HDL</p> <p>Product #: 29151.0000²</p>	 <p>FUNNEL ASSY,SST-PP ORANGE HDL</p> <p>Product #: 29151.0001²</p>	 <p>WATER FILTER SYSTEM,EQ-17-TL</p> <p>Product #: 30200.1000³</p>	 <p>WATER FILTER,IN LINE ED-17-TL</p> <p>Product #: 30201.1001³</p>
 <p>SYSTEM, WEQ-10(1.5)5L</p> <p>Product #: 56000.0024¹</p>	 <p>CARTRIDGE, WEQ-10 (1.5)5L</p> <p>Product #: 56000.0121¹</p>	 <p>CARTRIDGE, WEQ-10.3 (1.67)5L</p> <p>Product #: 56000.0137¹</p>		

¹NSF Certified ²NSF Certified with spec sheet model listed ³NSF Certified under Solventum Purification ⁴NSF Certified under Mavea LLC ⁵NSF Certified under Zojirushi ⁶NSF Certified under Qins Inc ⁷NSF COMPONENT Certified





BUNN® reserves the right to change specifications and product design without notice. Such revisions do not entitle the buyer to corresponding changes, improvements, additions or replacements for previously purchased equipment. For most current specifications and other info visit bunn.com.

Last Updated:
01/16/2026

Serving & Holding Options: WAVE COMBO(39900.0020)

 <p>AIRPOT, 2.5L SST LA SINGLE PK</p> <p>Product #: 32125.0000⁶ Mfr#:SVAP-2500F-N</p>	 <p>AIRPOT, 2.5L SST LA 6/ CASE</p> <p>Product #: 32125.0100⁶ Mfr#:SVAP-2500F-N</p>	 <p>AIRPOT, 3.0L SST LA SINGLE PK</p> <p>Product #: 32130.0000⁶ Mfr#:SVAP-3000F-N</p>	 <p>AIRPOT, 3.0L SST LA 6/ CASE</p> <p>Product #: 32130.0100⁶ Mfr#:SVAP-3000F-N</p>	 <p>THERMAL CARAFE, BLK 1.83 L 1PK</p> <p>Product #: 36029.0001⁵ Mfr#:SH-DE19A</p>
--	--	--	--	---

 <p>THERMAL CARAFE,ORN 1.9L 12PK</p> <p>Product #: 36252.0000⁵ Mfr#:SH-DE19A</p>	 <p>THERMAL CARAFE,ORN 1.9L 1PK</p> <p>Product #: 36252.0001⁵ Mfr#:SH-DE19A</p>	 <p>PITCHER,SST 1.9L TALL- SNGL PK</p> <p>Product #: 39430.0000⁶ Mfr#:SVP-1901DSG</p>	 <p>PITCHER,SST 1.9L TALL-6/CASE</p> <p>Product #: 39430.0100⁶ Mfr#:SVP-1901DSG</p>	 <p>CARAFE,SST 1.9L SHRT BLK 1</p> <p>Product #: 40163.0000⁶</p>
--	--	--	--	---

<p>NO IMAGE AVAILABLE</p> <p>THERMAL SRVR, 2.5L 6/ CS NO BASE GL LINR</p> <p>Product #: 45882.0001¹</p>

¹NSF Certified ²NSF Certified with spec sheet model listed ³NSF Certified under Solventum Purification ⁴NSF Certified under Mavea LLC ⁵NSF Certified under Zojirushi ⁶NSF Certified under Qins Inc ⁷NSF COMPONENT Certified



BUNN® reserves the right to change specifications and product design without notice. Such revisions do not entitle the buyer to corresponding changes, improvements, additions or replacements for previously purchased equipment. For most current specifications and other info visit bunn.com.

Last Updated:
01/16/2026