

# G3 HD BLK

Height: 27.2" (69.1cm) Width: 7.4" (18.8cm) Depth: 16.6" (42.2cm)



- Bag switch stops motor when bag is removed and prevents grinding before bag is in place
- Fast grinding—one pound in under 30 seconds
- Turbo action draws coffee through grind chamber for greater grinding efficiency
- Wide range of grinds can be selected
- Convenient cleaning lever ensures complete clean out of coffee from grind chamber
- Four year warranty on grinding burrs
- Heavy-duty precision burrs for quality, finer grinds
- Single hopper holds 3lb (1.36kg) of regular, decaf or specialty coffee beans
- PROP 65 Warning Decal included in packaging with equipment

Agency:



## Specifications

**Product #:** 22100.0000

**Finish:** Black

**Hoppers:** One

**Hopper Capacity:** 3.00 lbs (1.361 kgs)

## Electrical & Capacity

Volts*	Amps	Watts	Cord Attached	Plug Type	8oz cups/hr 236ml cups/hr	Input H <sup>2</sup> O Temp.	Phase	# Wires plus Ground	Hertz
120	11	1320	Yes	NEMA 5-15P	-	60°F (15.5°C)	1	2	60

\*When a BUNN is machine rated 120/208-240V, 120/208V or 120/240V, the higher voltage is the supply voltage needed to power the machine. The 120V is there to supply power to some components rated 120V in the machine, but it is not the supply voltage and would not power the machine if the machine is marked with the before mentioned ratings.

## Additional Features

## Plumbing Requirements

PSI	kPa	Fitting Supplied	Water Flow Required (GPM)
-	-	-	-

## CAD Drawings

2D	Revit	KLC
●		

**WARNING:** This product can expose you to chemicals including Bisphenol A (BPA), which is known to the State of California to cause birth defects or other reproductive harm. For more information go to [www.P65Warnings.ca.gov](http://www.P65Warnings.ca.gov)



BUNN® reserves the right to change specifications and product design without notice. Such revisions do not entitle the buyer to corresponding changes, improvements, additions or replacements for previously purchased equipment. For most current specifications and other info visit [bunn.com](http://bunn.com).

Last Updated:  
01/12/2021

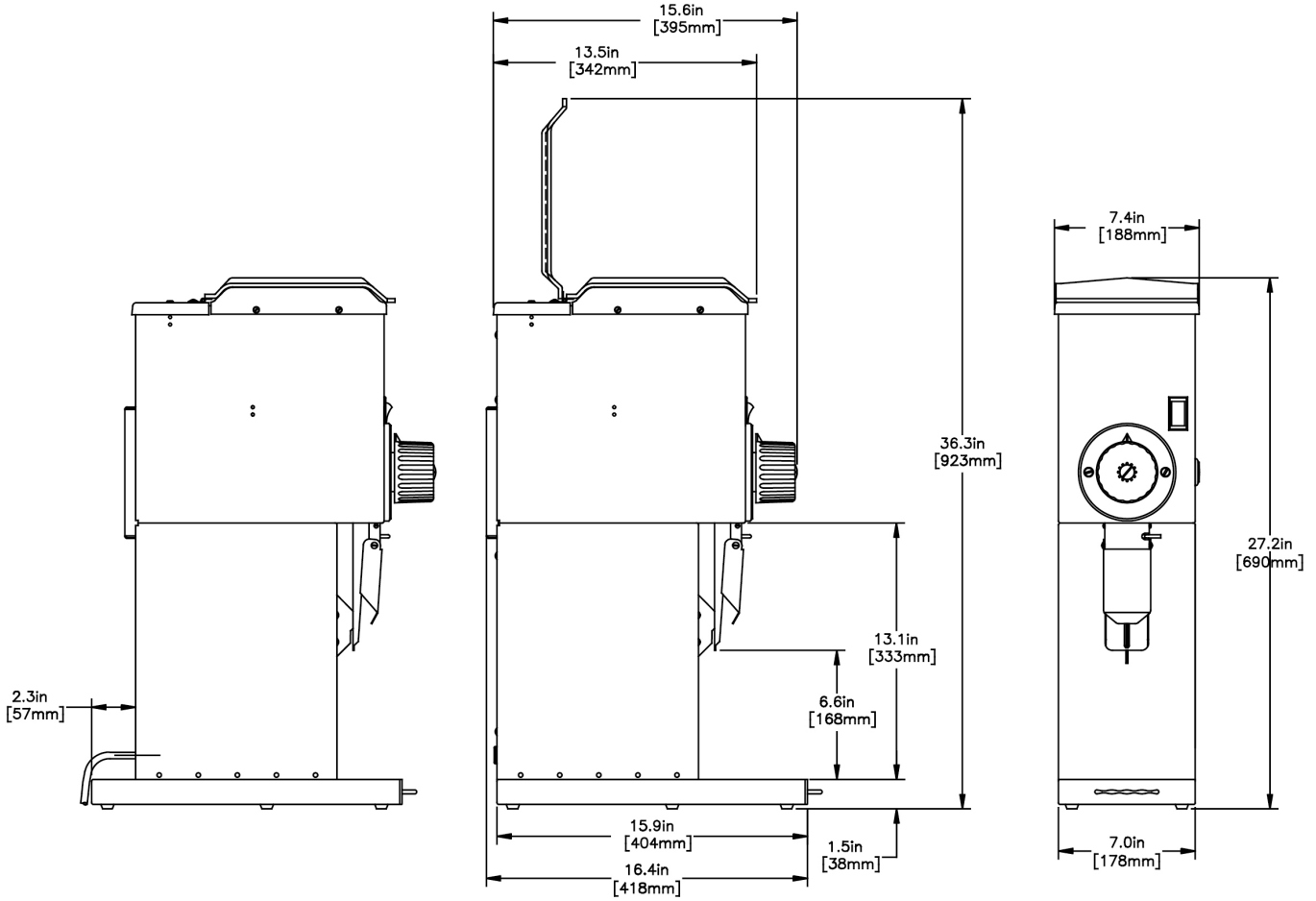
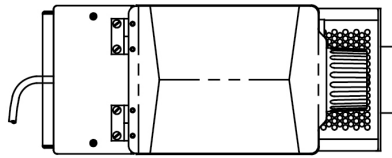

	Unit			Shipping				
	Height	Width	Depth	Height	Width	Depth	Weight	Volume
English	27.2 in.	7.4 in.	16.6 in.	32.8 in.	13.6 in.	23.1 in.	56.200 lbs	5.972 ft <sup>3</sup>
Metric	69.1 cm	18.8 cm	42.2 cm	83.2 cm	34.6 cm	58.7 cm	25.492 kgs	0.169 m <sup>3</sup>



BUNN® reserves the right to change specifications and product design without notice. Such revisions do not entitle the buyer to corresponding changes, improvements, additions or replacements for previously purchased equipment. For most current specifications and other info visit [bunn.com](http://bunn.com).

Last Updated:  
01/12/2021

# Related Products & Accessories:G3 HD BLK(22100.0000)



BURR SET KIT, NEW

Product #: 05861.1002



BURR SET KIT, TURKISH GRIND

Product #: 11285.1000

HOPPER MAGNET KIT

Product #: 20204.1702



BUNN® reserves the right to change specifications and product design without notice. Such revisions do not entitle the buyer to corresponding changes, improvements, additions or replacements for previously purchased equipment. For most current specifications and other info visit [bunn.com](http://bunn.com).

Last Updated:  
01/12/2021

# Serving & Holding Options: G3 HD BLK(22100.0000)

\*Serving and Holding selections are currently unavailable. Please contact your sales representative to find out more information.\*



BUNN® reserves the right to change specifications and product design without notice. Such revisions do not entitle the buyer to corresponding changes, improvements, additions or replacements for previously purchased equipment. For most current specifications and other info visit [bunn.com](http://bunn.com).

Last Updated:  
01/12/2021