

GVH-2, 120V

Height: 24.6" (62.5cm) Width: 7.3" (18.5cm) Depth: 15.8" (40.1cm)



- New sleek styling with visual 2 lb (.91kg) hopper promotes freshly ground coffee
- Versatile design allows grinding into bags, cans, and cups and other containers to meet a multitude of customer needs
- Fast grinding – two pounds (.91kg) in about 60 seconds – maximizes speed of service
- 340° dial resolution for precise tuning of grind particle size
- Ergonomic clamp holds smaller size bags and containers in place for hands-free operation
- Easy to use cleaning lever ensures complete removal of all ground coffee from the grind chamber
- Precision Rockwell 65C hard burrs provide consistency, grind after grind
- Bag switch prevents grinding before bag/container is in place
- Industry leading grinding burr warranty

Agency:



Specifications

Product #: 55600.0200

Finish: Stainless

Hoppers: One

Hopper Capacity: 2.00 lbs (0.907 kgs)

Additional Features

Electrical & Capacity

Volts*	Amps	Watts	Cord Attached	Plug Type	8oz cups/hr 236ml cups/hr	Input H ₂ O Temp.	Phase	# Wires plus Ground	Hertz
120	11	1320	Yes	NEMA 5-15P	-	60°F (15.5°C)	1	2	60

*When a BUNN is machine rated 120/208-240V, 120/208V or 120/240V, the higher voltage is the supply voltage needed to power the machine. The 120V is there to supply power to some components rated 120V in the machine, but it is not the supply voltage and would not power the machine if the machine is marked with the before mentioned ratings.

Plumbing Requirements

PSI	kPa	Fitting Supplied	Water Flow Required (GPM)
-	-	-	-

CAD Drawings

2D	Revit	KLC
●		

WARNING: This product can expose you to chemicals including Bisphenol A (BPA), which is known to the State of California to cause birth defects or other reproductive harm. For more information go to www.P65Warnings.ca.gov



BUNN® reserves the right to change specifications and product design without notice. Such revisions do not entitle the buyer to corresponding changes, improvements, additions or replacements for previously purchased equipment. For most current specifications and other info visit bunn.com.

Last Updated:
08/15/2024

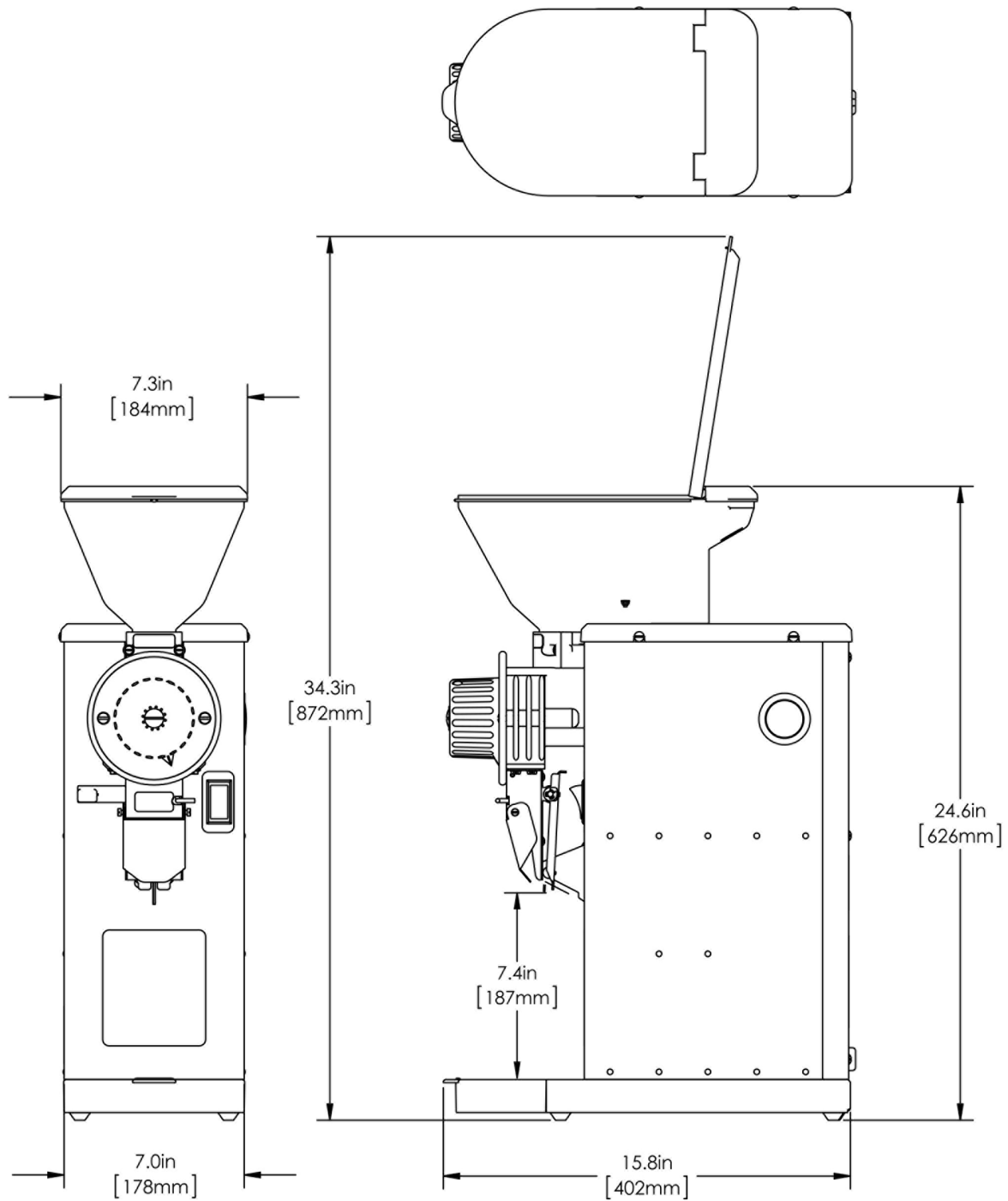

	Unit			Shipping				
	Height	Width	Depth	Height	Width	Depth	Weight	Volume
English	24.6 in.	7.3 in.	15.8 in.	31.4 in.	11.2 in.	20.1 in.	54.240 lbs	4.076 ft ³
Metric	62.5 cm	18.5 cm	40.1 cm	79.7 cm	28.4 cm	51.0 cm	24.603 kgs	0.115 m ³



BUNN® reserves the right to change specifications and product design without notice. Such revisions do not entitle the buyer to corresponding changes, improvements, additions or replacements for previously purchased equipment. For most current specifications and other info visit bunn.com.

Last Updated:
08/15/2024

Related Products & Accessories:GVH-2, 120V(55600.0200)



BURR SET KIT, NEW

Product #: 05861.1002



BURR SET KIT, TURKISH GRIND

Product #: 11285.1000

CHUTE ASSY, TRIFECTA - GVH

Product #: 55032.0000



BUNN® reserves the right to change specifications and product design without notice. Such revisions do not entitle the buyer to corresponding changes, improvements, additions or replacements for previously purchased equipment. For most current specifications and other info visit bunn.com.

Last Updated:
08/15/2024

Serving & Holding Options: GVH-2, 120V(55600.0200)

Serving and Holding selections are currently unavailable. Please contact your sales representative to find out more information.



BUNN® reserves the right to change specifications and product design without notice. Such revisions do not entitle the buyer to corresponding changes, improvements, additions or replacements for previously purchased equipment. For most current specifications and other info visit bunn.com.

Last Updated:
08/15/2024