

Ultra®-2 BLK/SST PAF Powdered Autofill

Height: 41.8" Width: 16.0" Depth: 27.5"
(106.2cm) (40.6cm) (69.9cm)



- Patented beverage monitoring technology and reversing auger design ensure consistent, great tasting frozen beverages
- Two Large product hoppers hold 2 gallons (7.57L) each to maximize serving capacity to meet demand
- User interface communicates need for cleaning and maintenance, and provides simple programming, cleaning and preventive maintenance guides to ensure reliable operation and performance – minimizing down time and maximizing serving capacity and profits
- Powder auto-fill system reduces labor and ensures your products are ready to serve at peak demand
- LED lighted merchandisers in hopper lids bring high visibility to front- of-house applications
- Extended Dispense Handle
- Sanitation listings NSF 18 and NSF 6 (Dairy)
- R452A refrigerant reduces impact on environment by lowering Global Warming Potential (GWP)

Agency:



Specifications

Product #: 34000.0501

Autofill: Powder

Finish: Stainless/Black

Hoppers: Two

Refrigerant: R452A

Handle: Extended Handle

Legs: 4" Black Legs

Additional Features

Electrical & Capacity

Volts*	Amps	Watts	Cord Attached	Plug Type	8oz cups/hr 236ml cups/hr	Input H ² O Temp.	Phase	# Wires plus Ground	Hertz
120	12	1440	Yes	NEMA 5-15P	-	60°F (15.5°C)	1	2	50/60

*When a BUNN is machine rated 120/208-240V, 120/208V or 120/240V, the higher voltage is the supply voltage needed to power the machine. The 120V is there to supply power to some components rated 120V in the machine, but it is not the supply voltage and would not power the machine if the machine is marked with the before mentioned ratings.

Plumbing Requirements

PSI	kPa	Fitting Supplied	Water Flow Required (GPM)
-	-	-	-

CAD Drawings

2D	Revit	KLC
●		



BUNN® reserves the right to change specifications and product design without notice. Such revisions do not entitle the buyer to corresponding changes, improvements, additions or replacements for previously purchased equipment. For most current specifications and other info visit bunn.com.

Last Updated:
05/03/2021

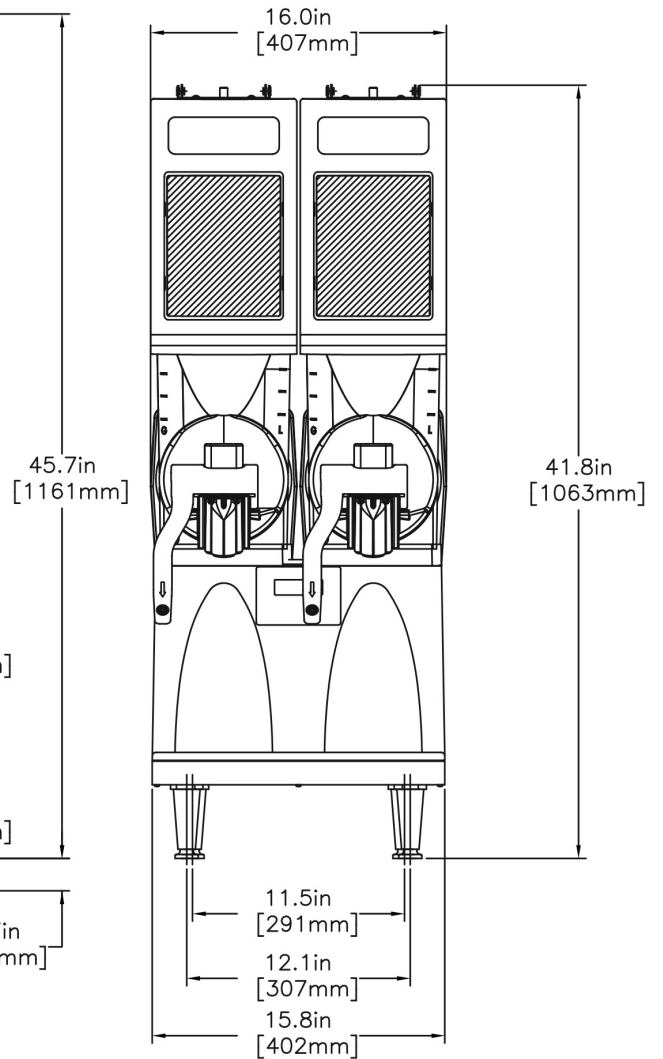
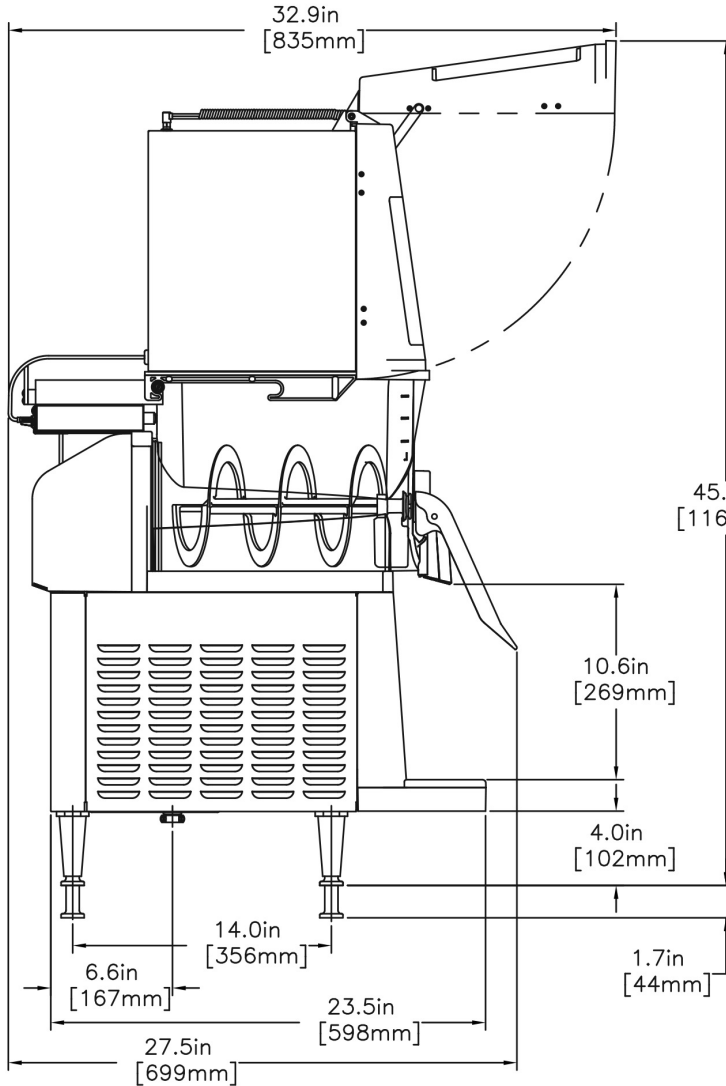
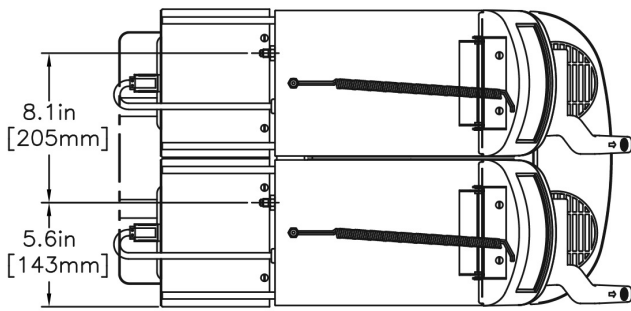

	Unit			Shipping				
	Height	Width	Depth	Height	Width	Depth	Weight	Volume
English	41.8 in.	16.0 in.	27.5 in.	28.7 in.	19.1 in.	24.6 in.	192.750 lbs	7.819 ft ³
Metric	106.2 cm	40.6 cm	69.9 cm	72.9 cm	48.6 cm	62.5 cm	87.431 kgs	0.221 m ³



BUNN® reserves the right to change specifications and product design without notice. Such revisions do not entitle the buyer to corresponding changes, improvements, additions or replacements for previously purchased equipment. For most current specifications and other info visit bunn.com.

Last Updated:
05/03/2021

Related Products & Accessories: Ultra®-2 BLK/SST PAF Powdered Autofill(34000.0501)



DRIP TRAY ASSY,
LOWER-BLK

Product #: 28086.0001

COVER, DRIP TRAY
ULTRA 2 BLK

Product #: 32068.0001



BUNN® reserves the right to change specifications and product design without notice. Such revisions do not entitle the buyer to corresponding changes, improvements, additions or replacements for previously purchased equipment. For most current specifications and other info visit bunn.com.

Last Updated:
05/03/2021

Serving & Holding Options: Ultra®-2 BLK/SST PAF Powdered Autofill(34000.0501)

Serving and Holding selections are currently unavailable. Please contact your sales representative to find out more information.



BUNN® reserves the right to change specifications and product design without notice. Such revisions do not entitle the buyer to corresponding changes, improvements, additions or replacements for previously purchased equipment. For most current specifications and other info visit bunn.com.

Last Updated:
05/03/2021