

# LCA-2 (w/Scholle 1910 3/16", Long Feed)

Height: 31.3" Width: 12.2" Depth: 24.8"  
(79.5cm) (31.0cm) (63.0cm)



- Accommodates 1/2gal (1.9L) and most 1gal (3.8L) bag-in-box (BIB) containers
- Attractive appearance and narrow 12" (30.5 cm) width
- FlavorGard® technology continuously monitors extract-to-water ratio and assures flavor consistency
- Refill or rinse LED lights alert the operator for concentrate or cleaning
- Ventilated Cabinet
- Insulated product cabinet assures maximum product life

Agency:



## Specifications

**Product #:** 34400.0031

**Finish:** Black

**Product Ratio:** 25:1-60:1

**Legs:** 4" Black Legs

**Connector:** Scholle 1910LX

**Water Access:** Plumbed

## Additional Features

Alt Disp Rate 2.5 oz/s(74ml/s)

Hot Water Button

## Electrical & Capacity

Volts*	Amps	Watts	Cord Attached	Plug Type	8oz cups/hr 236ml cups/hr	Input H <sub>2</sub> O Temp.	Phase	# Wires plus Ground	Hertz
120	13.2	1575	-	-	73	60°F (15.5°C)	1	2	60
208	21	4331	-	N/A	220	60°F (15.5°C)	1	2	60
240	24	5700	-	N/A	293	60°F (15.5°C)	1	2	60

\*When a BUNN is machine rated 120/208-240V, 120/208V or 120/240V, the higher voltage is the supply voltage needed to power the machine. The 120V is there to supply power to some components rated 120V in the machine, but it is not the supply voltage and would not power the machine if the machine is marked with the before mentioned ratings.

## Plumbing Requirements

PSI	kPa	Fitting Supplied	Water Flow Required (GPM)
20-90	138-621	3/8" Male Flare Fitting	-

## CAD Drawings

2D	Revit	KLC
●		



BUNN® reserves the right to change specifications and product design without notice. Such revisions do not entitle the buyer to corresponding changes, improvements, additions or replacements for previously purchased equipment. For most current specifications and other info visit [bunn.com](http://bunn.com).

Last Updated:  
10/15/2020

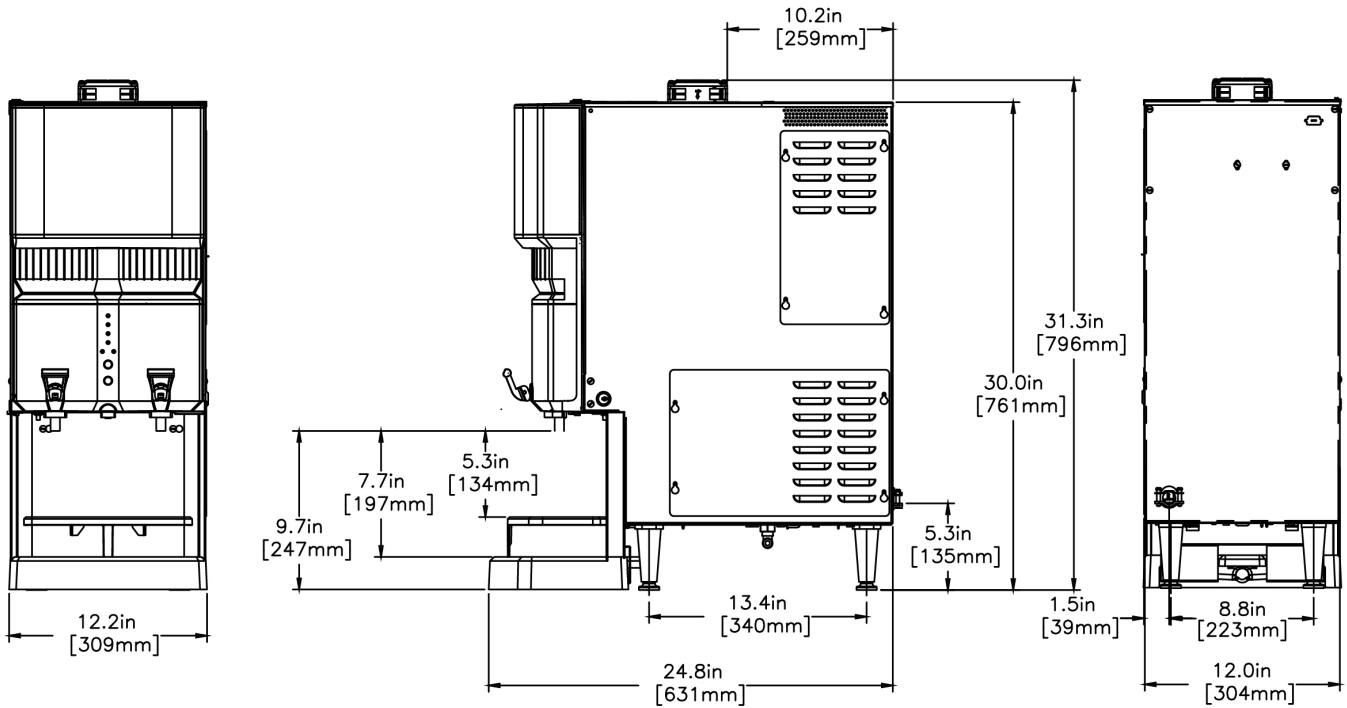
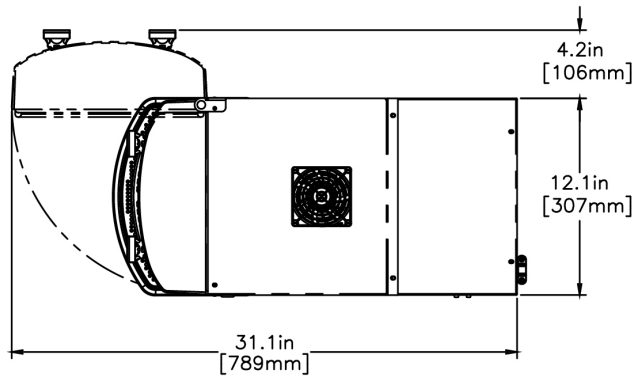

	Unit			Shipping				
	Height	Width	Depth	Height	Width	Depth	Weight	Volume
English	31.3 in.	12.2 in.	24.8 in.	41.3 in.	21.9 in.	28.1 in.	90.210 lbs	14.687 ft <sup>3</sup>
Metric	79.5 cm	31.0 cm	63.0 cm	104.8 cm	55.6 cm	71.4 cm	40.919 kgs	0.416 m <sup>3</sup>



BUNN® reserves the right to change specifications and product design without notice. Such revisions do not entitle the buyer to corresponding changes, improvements, additions or replacements for previously purchased equipment. For most current specifications and other info visit [bunn.com](http://bunn.com).

Last Updated:  
10/15/2020

Related Products & Accessories:LCA-2 (w/Scholle 1910 3/16", Long Feed)(34400.0031)

ADPTR/TUBE PKG,  
SCHOLLE 3/16" LGFEED

---

Product #: 34400.0208



KIT,DISPENSE RATIO  
CAL LCA/LCC

---

Product #: 34843.1000



BUNN® reserves the right to change specifications and product design without notice. Such revisions do not entitle the buyer to corresponding changes, improvements, additions or replacements for previously purchased equipment. For most current specifications and other info visit [bunn.com](http://bunn.com).

Last Updated:  
10/15/2020

## Serving & Holding Options: LCA-2 (w/Scholle 1910 3/16", Long Feed)(34400.0031)

\*Serving and Holding selections are currently unavailable. Please contact your sales representative to find out more information.\*



BUNN® reserves the right to change specifications and product design without notice. Such revisions do not entitle the buyer to corresponding changes, improvements, additions or replacements for previously purchased equipment. For most current specifications and other info visit [bunn.com](http://bunn.com).

Last Updated:  
10/15/2020