

1.9L Thermal Pitcher (6pk)

Height: 11.3" Width: 6.5" Depth: 5.5"
(28.7cm) (16.5cm) (14.0cm)

•

Feature points are currently unavailable.



Agency:

Specifications

Product #: 39430.0100

Finish: Stainless/Black

Liner: Stainless Steel

Lid Color: Black

Additional Features

Holding Capacity

English	Metric
-	-



BUNN® reserves the right to change specifications and product design without notice. Such revisions do not entitle the buyer to corresponding changes, improvements, additions or replacements for previously purchased equipment. For most current specifications and other info visit bunn.com.

Last Updated:
11/13/2020

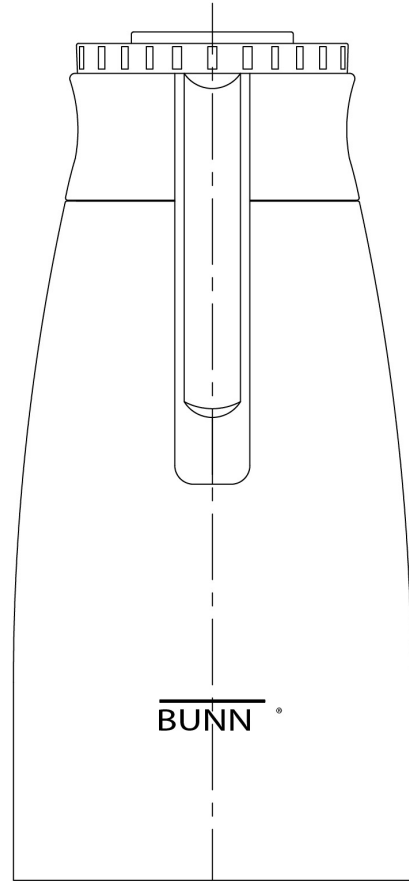
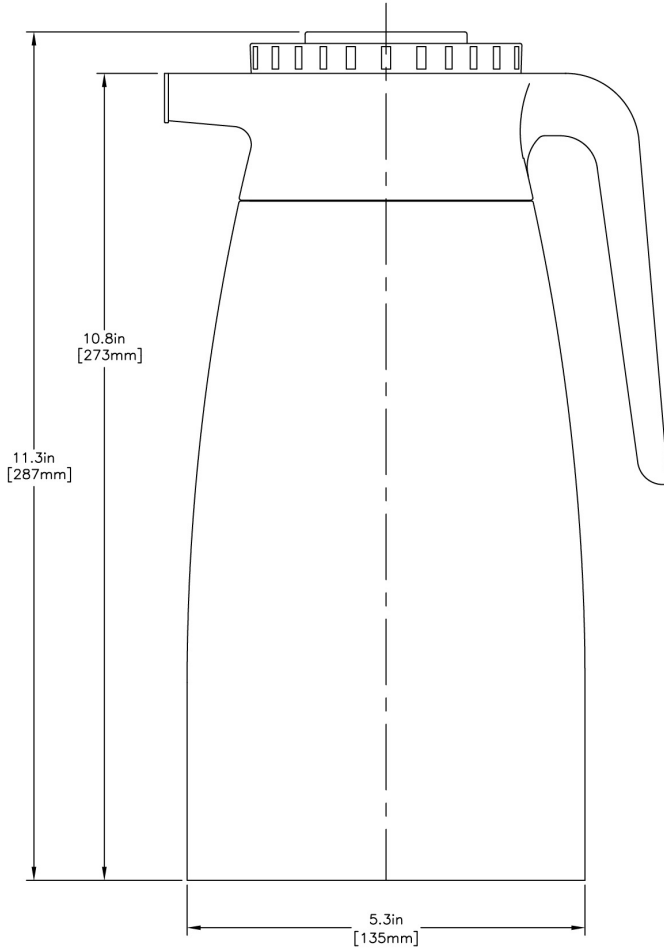
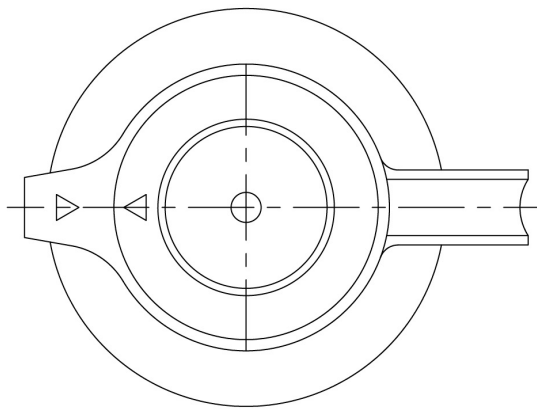

	Unit			Shipping				
	Height	Width	Depth	Height	Width	Depth	Weight	Volume
English	11.3 in.	6.5 in.	5.5 in.	12.0 in.	6.0 in.	5.8 in.	17.000 lbs	0.242 ft ³
Metric	28.7 cm	16.5 cm	14.0 cm	30.5 cm	15.2 cm	14.7 cm	7.711 kgs	0.007 m ³



BUNN® reserves the right to change specifications and product design without notice. Such revisions do not entitle the buyer to corresponding changes, improvements, additions or replacements for previously purchased equipment. For most current specifications and other info visit bunn.com.

Last Updated:
11/13/2020

Related Products & Accessories: 1.9L Thermal Pitcher (6pk)(39430.0100)

LID, CARAFE 1.9L-BLK

Product #: 40162.0000

LID, CARAFE 1.9L - ORN

Product #: 40162.0001



BUNN® reserves the right to change specifications and product design without notice. Such revisions do not entitle the buyer to corresponding changes, improvements, additions or replacements for previously purchased equipment. For most current specifications and other info visit bunn.com.

Last Updated:
11/13/2020

Model Compatibility: 1.9L Thermal Pitcher (6pk)(39430.0100)

Serving and Holding selections are currently unavailable. Please contact your sales representative to find out more information.



BUNN® reserves the right to change specifications and product design without notice. Such revisions do not entitle the buyer to corresponding changes, improvements, additions or replacements for previously purchased equipment. For most current specifications and other info visit bunn.com.

Last Updated:
11/13/2020